

HISTORICAL COLLECTION

WORLD WAR II



NORTH AMERICAN P-51D MUSTANG™

PLACE OF ORIGIN - UNITED STATES
 IN SERVICE - 1944 - 1960s
 ROLE - FIGHTER
 CREW - 1
 WINGSPAN - 11,28m (37')
 LENGTH - 9,83m (32' 3")
 HEIGHT - 4,08m (13' 4")
 WEIGHT - 3 465kg (7 635Lb)
 ENGINE - PACKARD MERLIN V-1650-7, 1 111kW (1 490HP)
 RATE OF CLIMB - 16,3m/s (3 200FT/MIN)
 MAXIMUM FLIGHT LEVEL - 12 800m (41 900FT)
 ARMAMENT - 6x 12,7mm (.50") BROWNING GUNS,
 453kg (1 000Lb) BOMBS, ROCKETS
 RANGE - 2 655km (1 650mi)
 SPEED - 708km/h (440MPH)

5860

Produced under license from Boeing.
 Boeing, North American Aviation, P-51 Mustang,
 the distinctive Boeing logos, product markings and
 trade dress are trademarks of The Boeing Company.

Printed in EU

PAD PRINTED
NO STICKERS



WARNING: CHOKING HAZARD-

Toy contains small parts.
 Not for children under 3 years.



PEFC Certified
 This product is from
 sustainably managed
 forests
 www.pefc.pl



UK
CA



152



NORTH AMERICAN P-51D MUSTANG™

SCALE 1:48

1

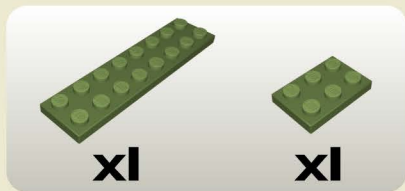
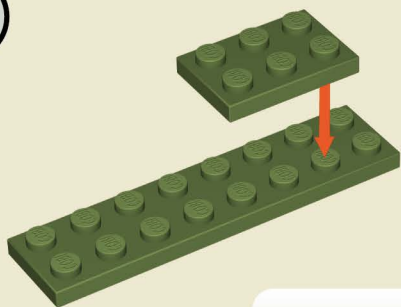

2

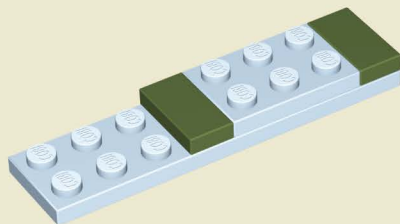

3

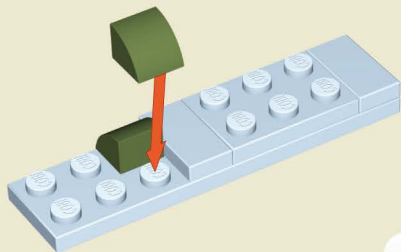

4

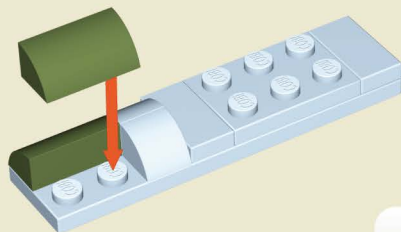

5

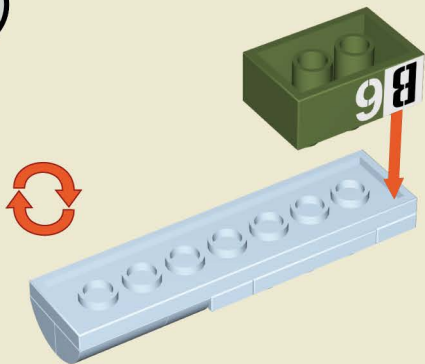

6

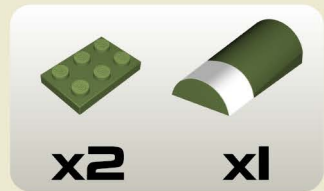
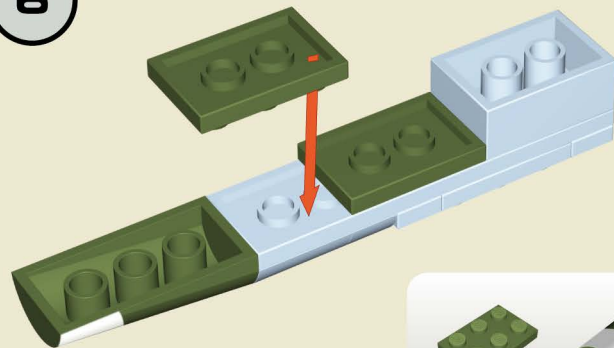

7

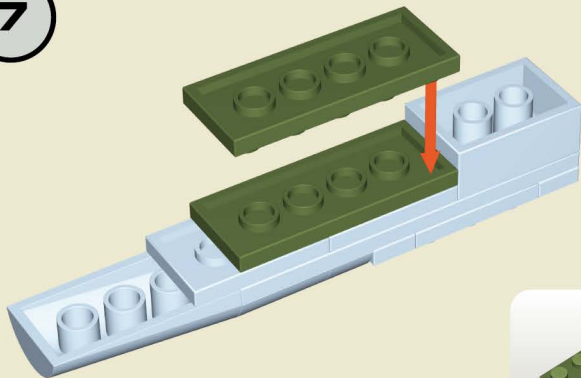

8

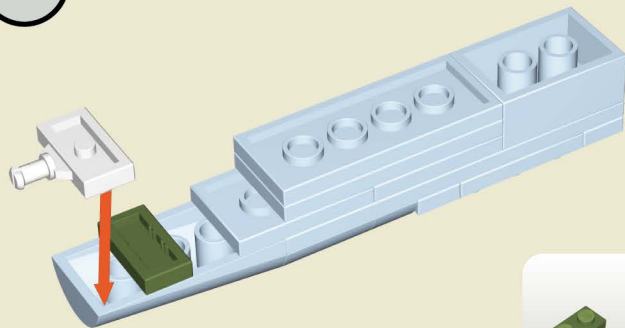

9

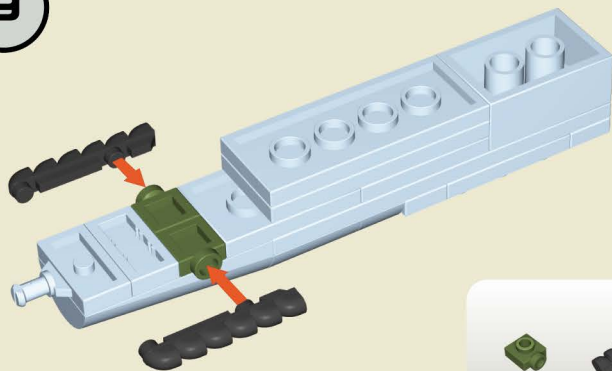

10

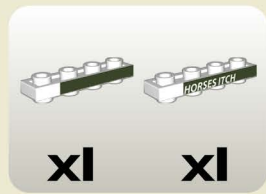
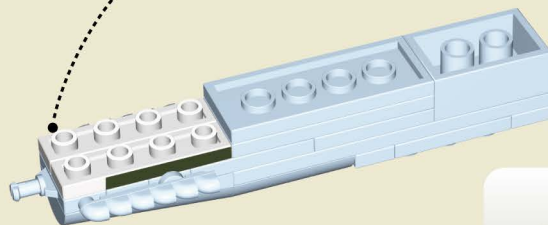

11

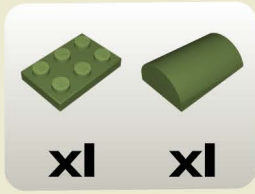
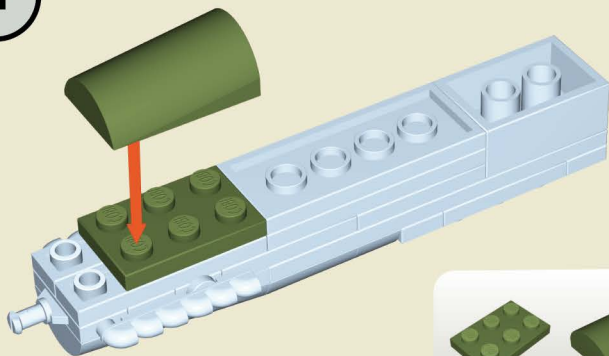

12

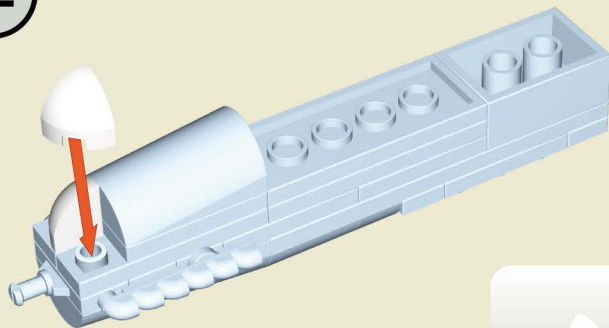

13

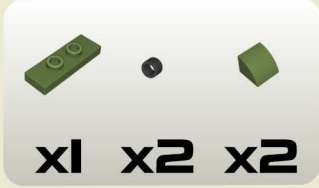
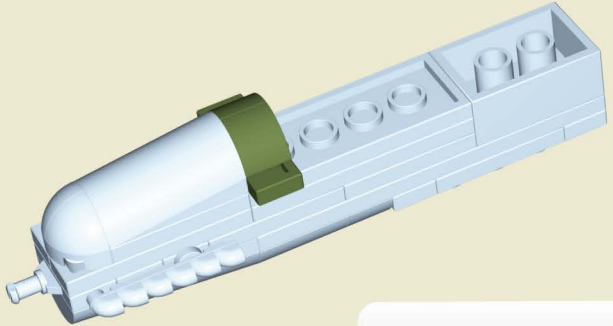
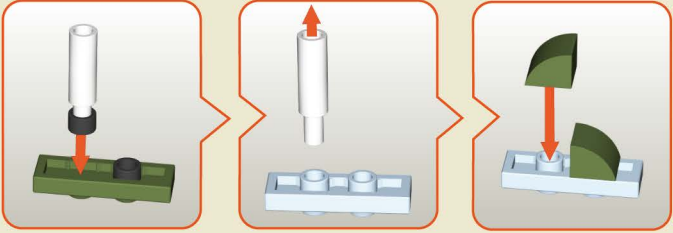

14

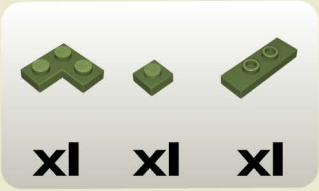
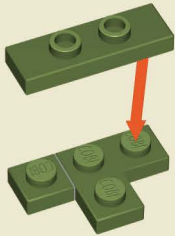

15



16

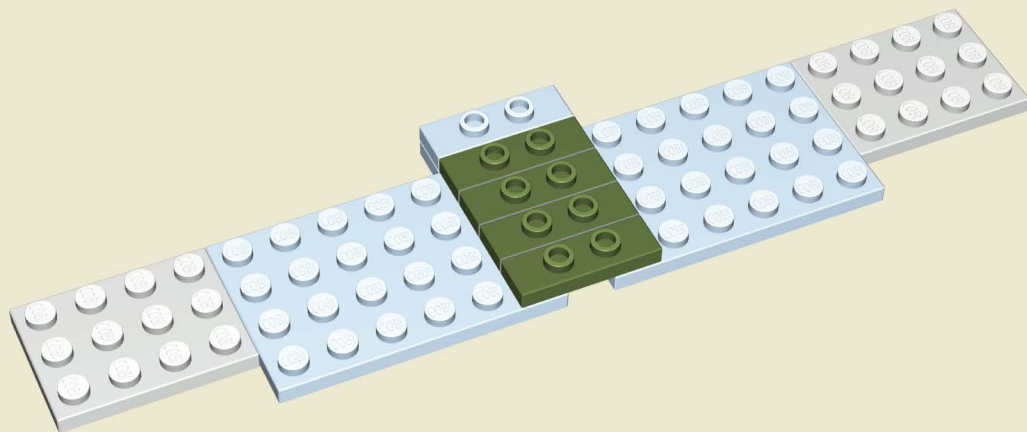

x4

x2

17

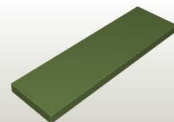
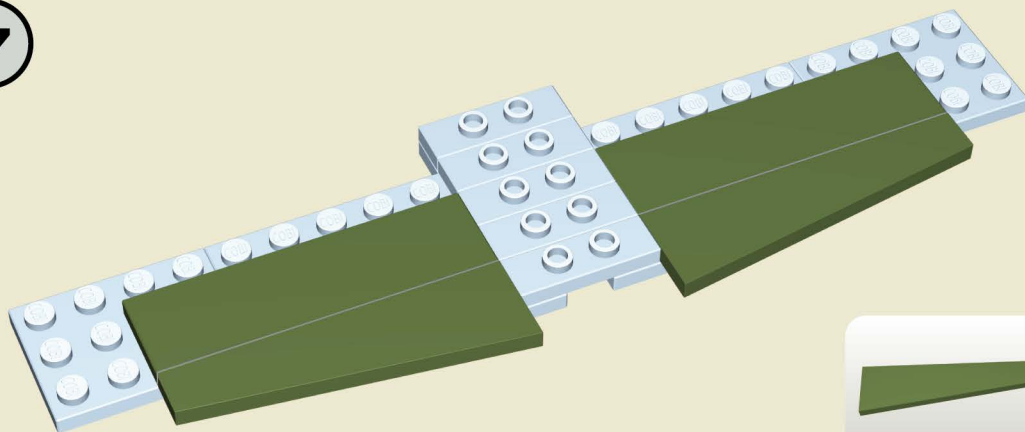

x1

x1

x2

18

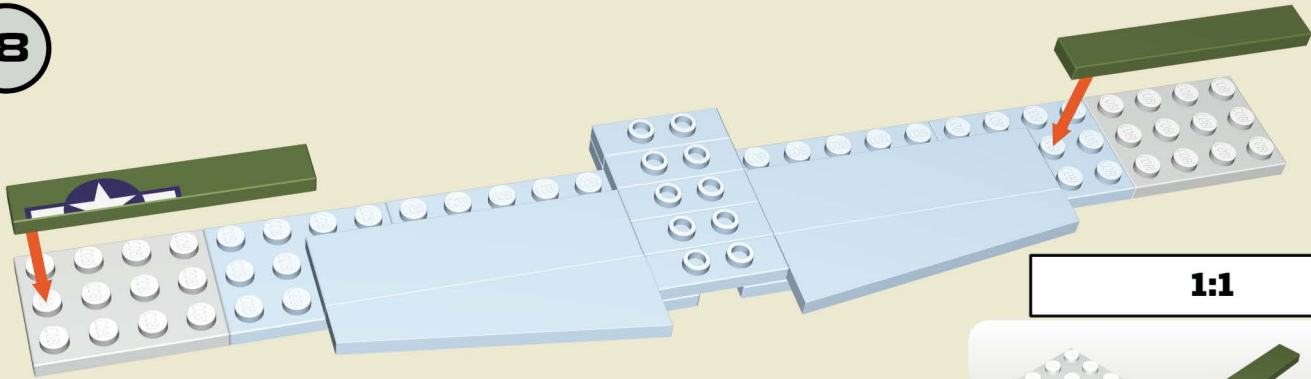

1:1

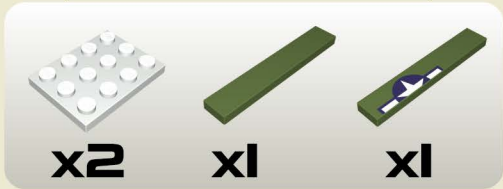

19

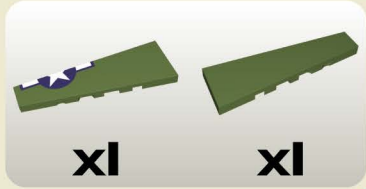
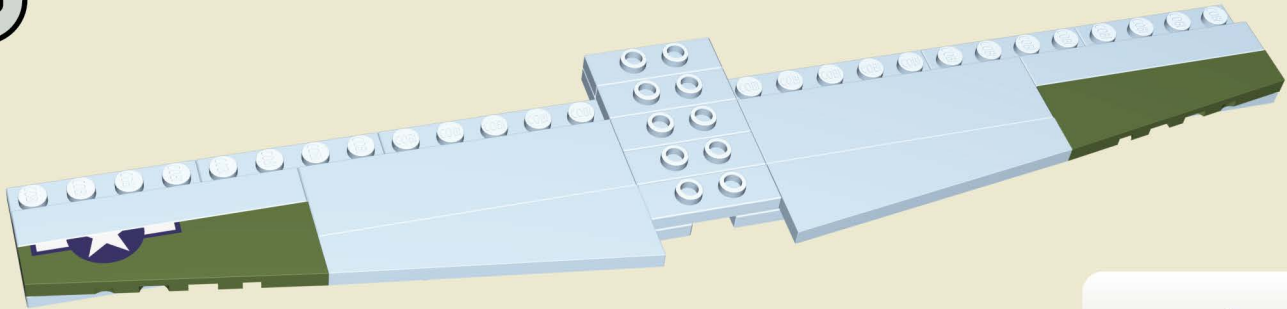

20

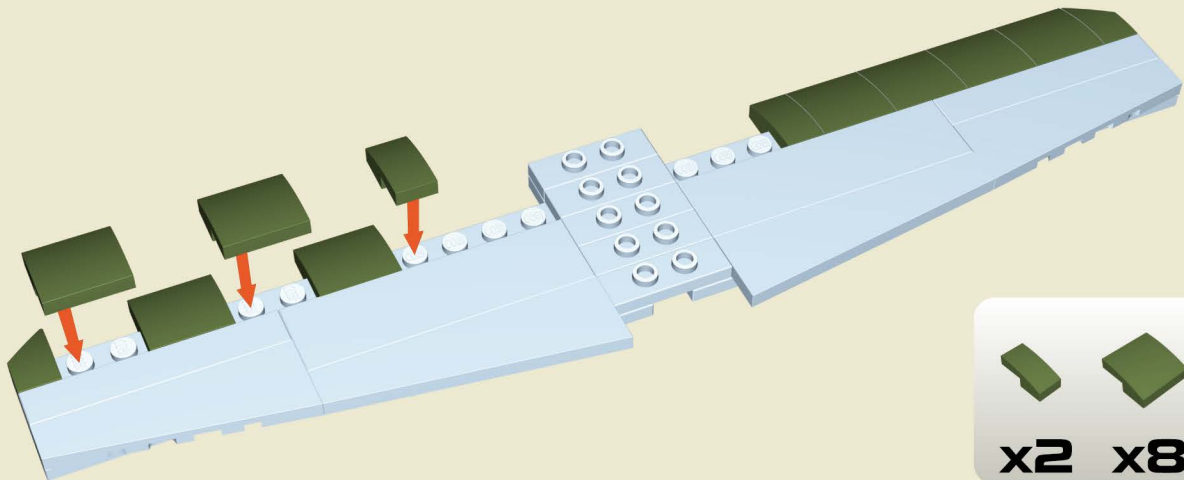

x2	x8	x1	x1

21

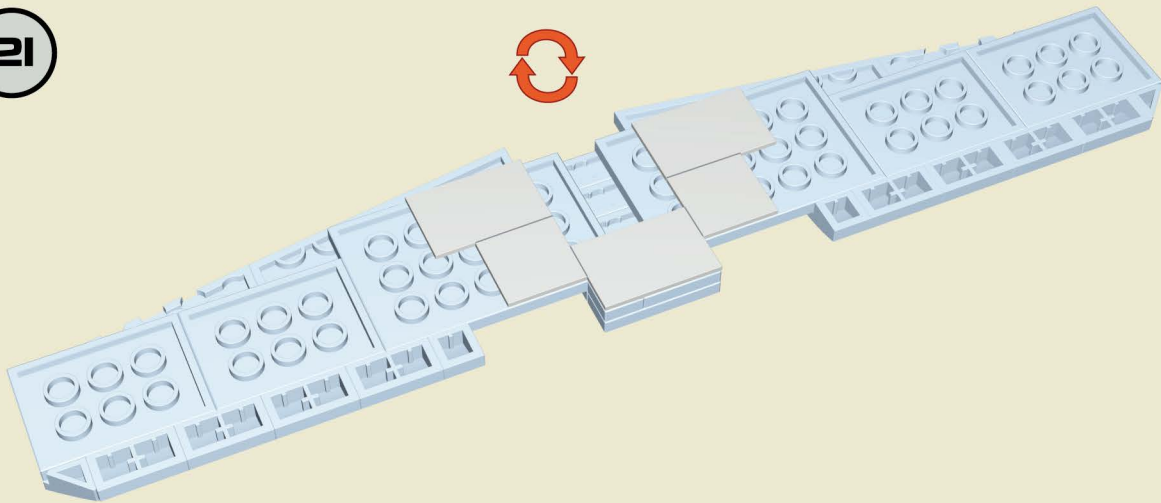

x2	x3

22



x2

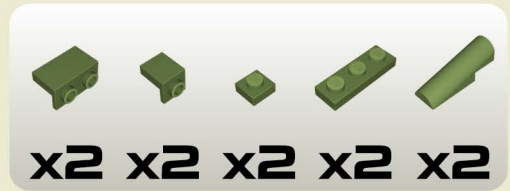
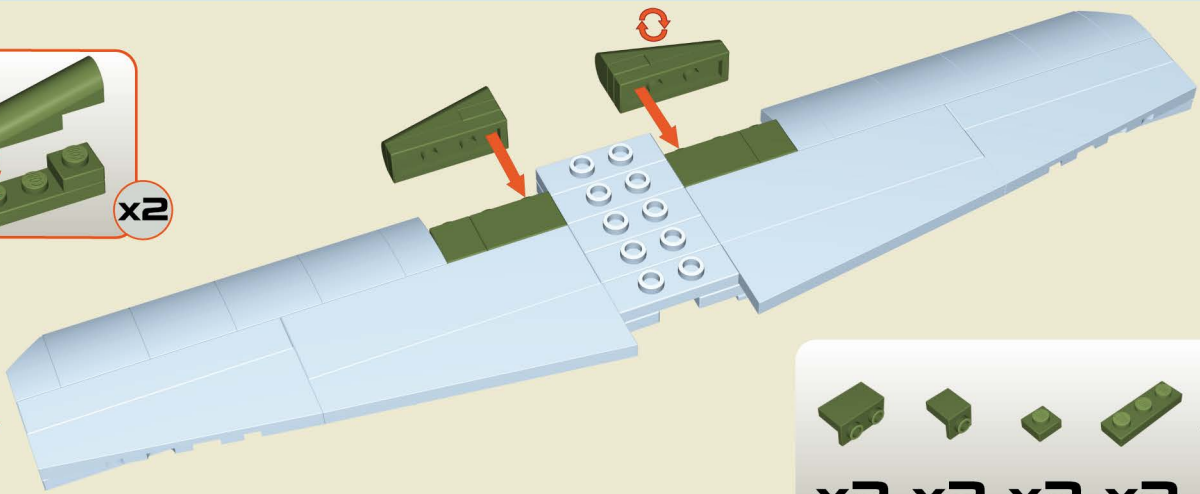

23

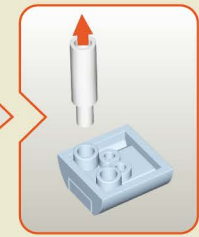
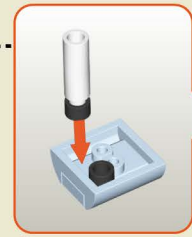
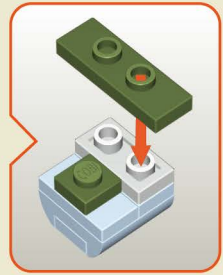

1:1

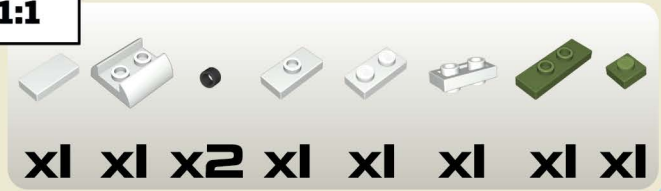

24

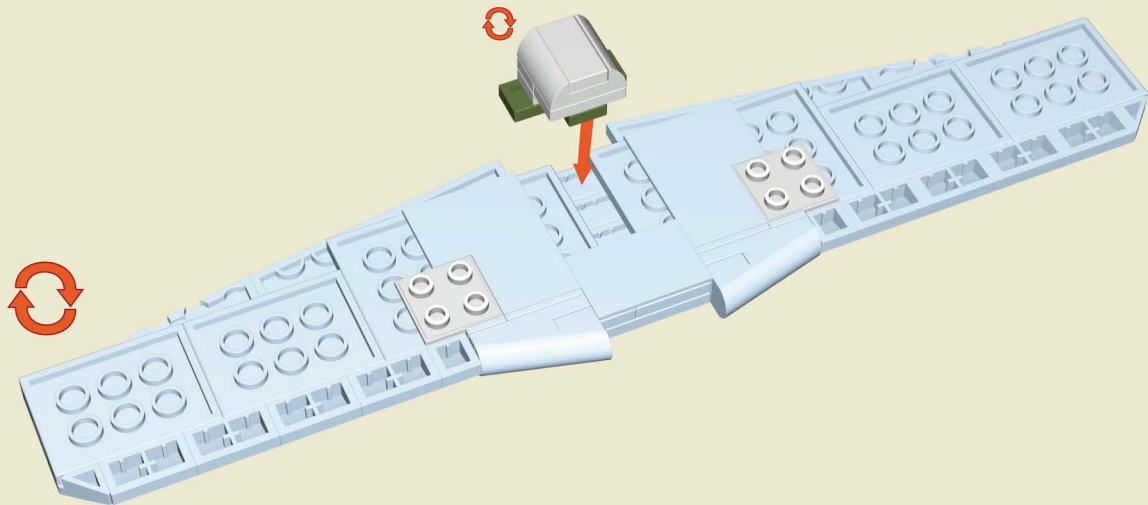

25

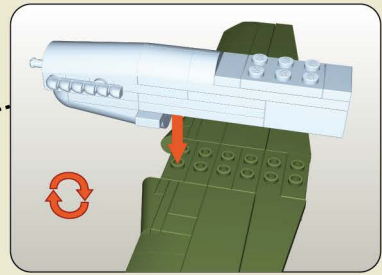
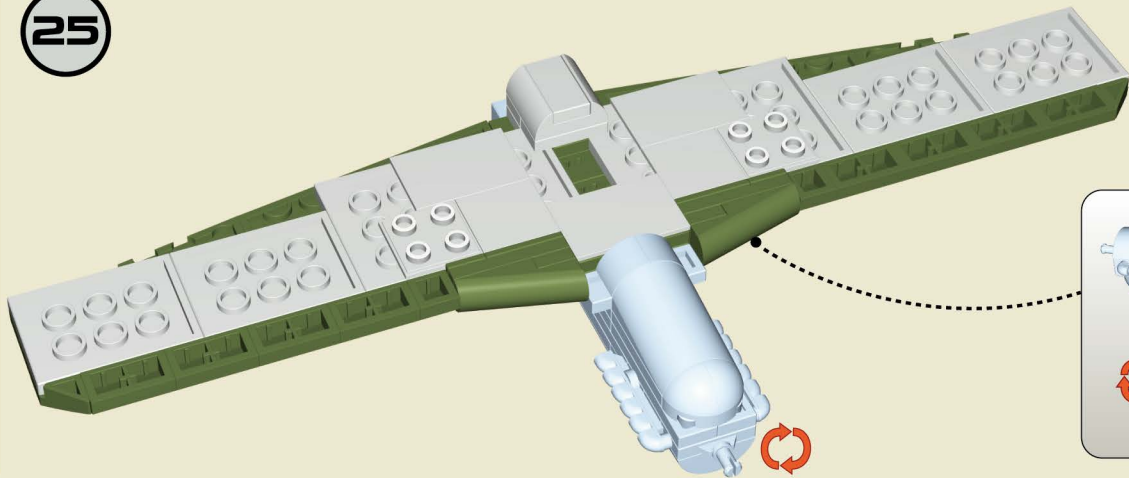

26

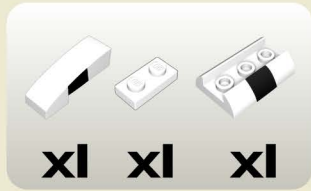
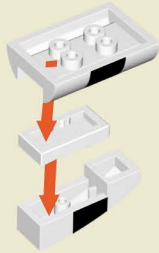

27

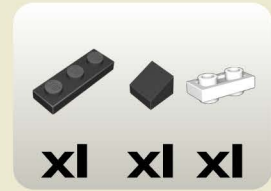
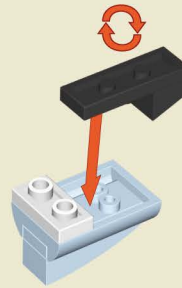

28

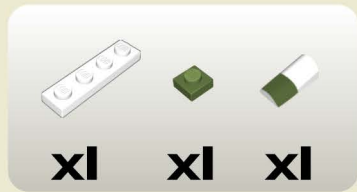
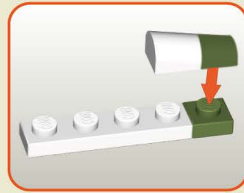
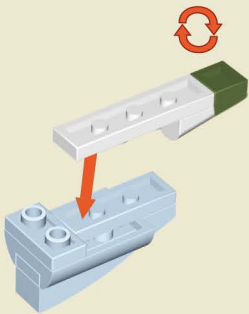

29

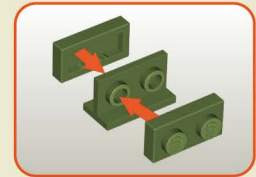
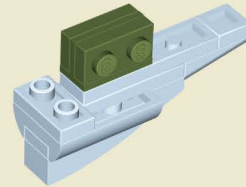

30

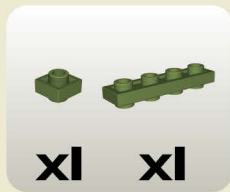
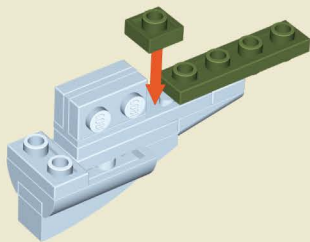

31

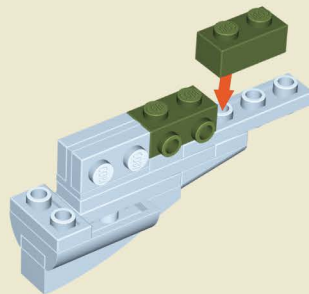

32

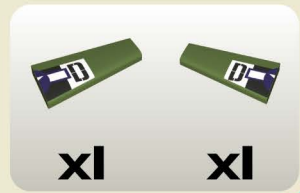
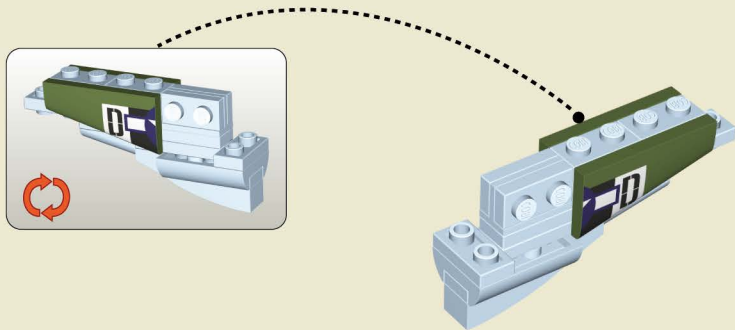

33

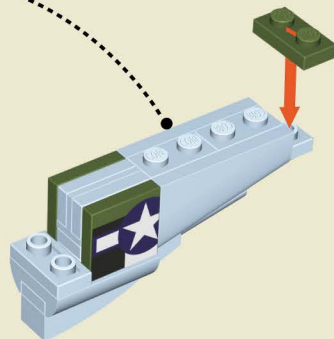
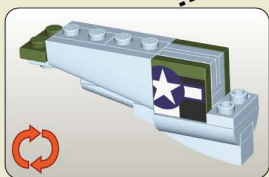

34

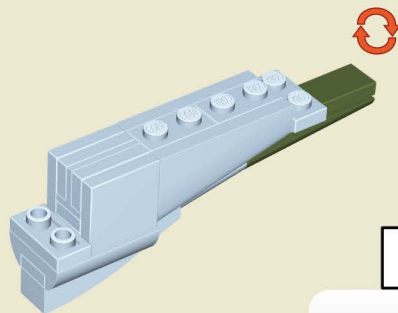
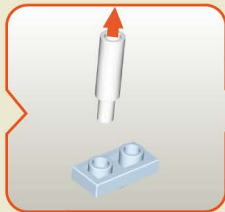
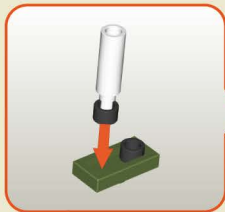

1:1

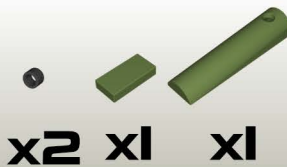

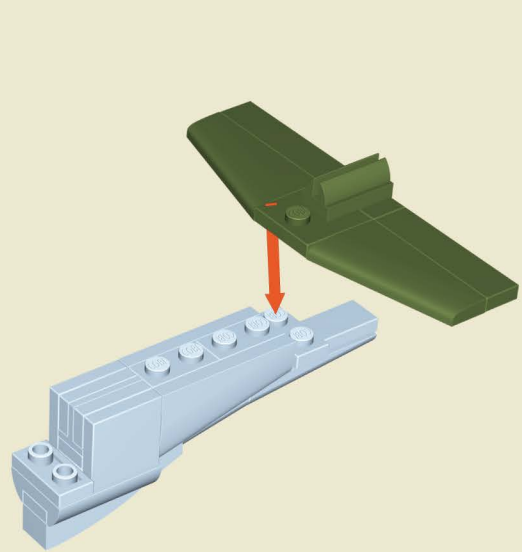
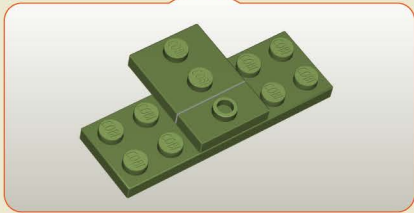
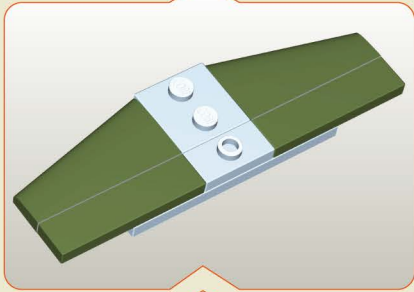
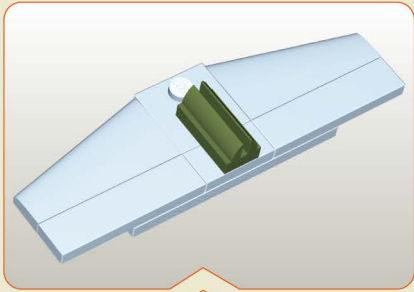

1:1



x1



x1



x1

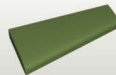

x1

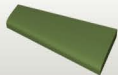

x1

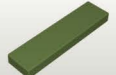

x2



x1

36

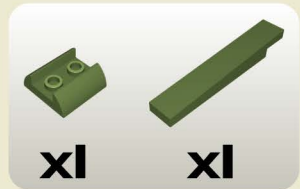
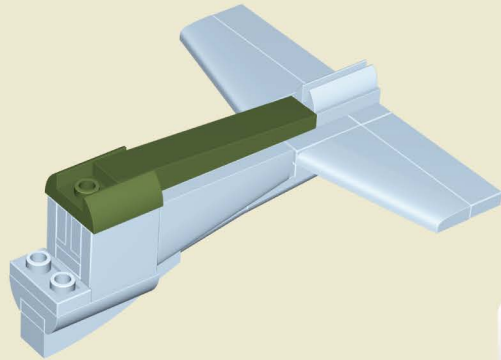
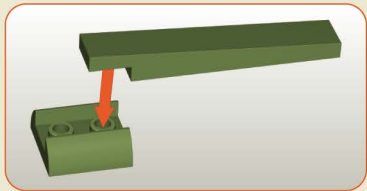

37

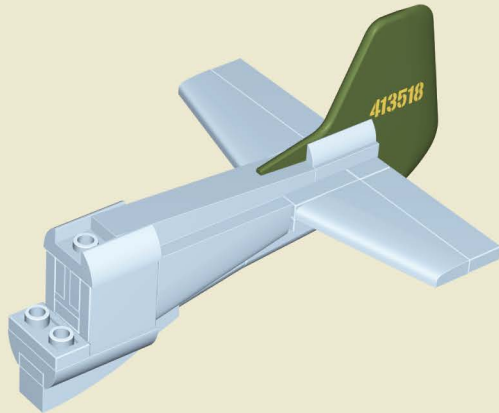

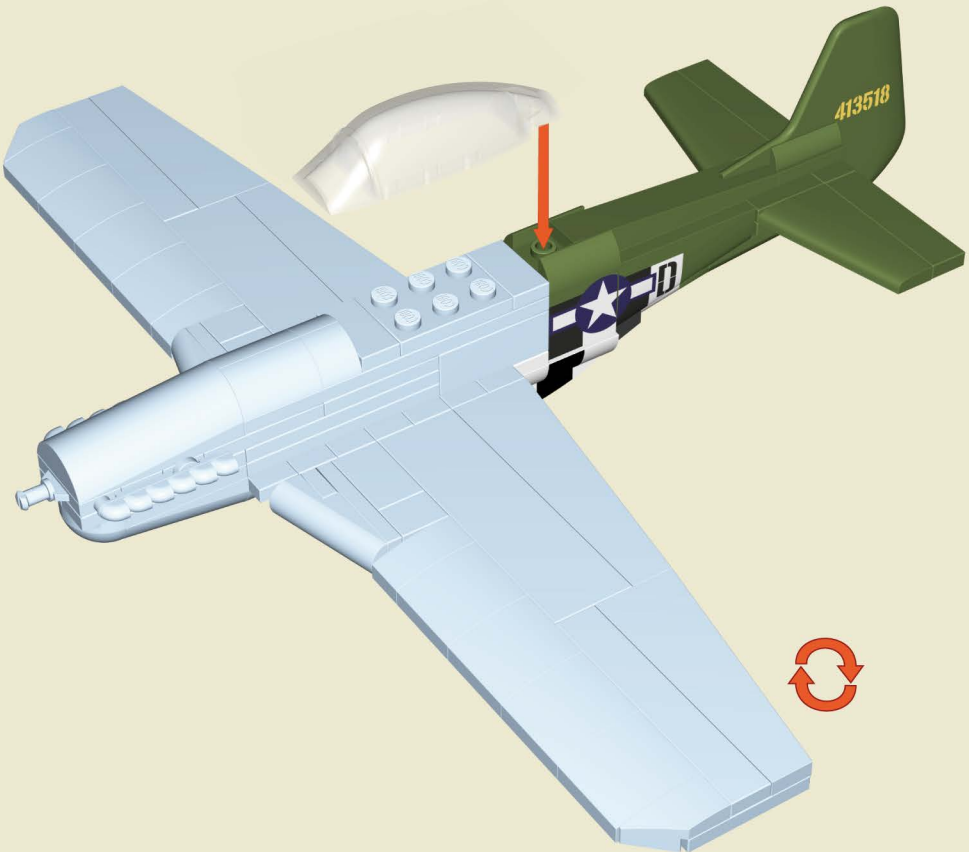

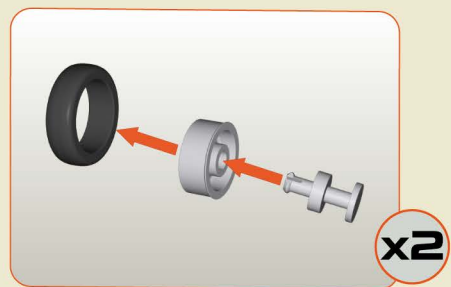
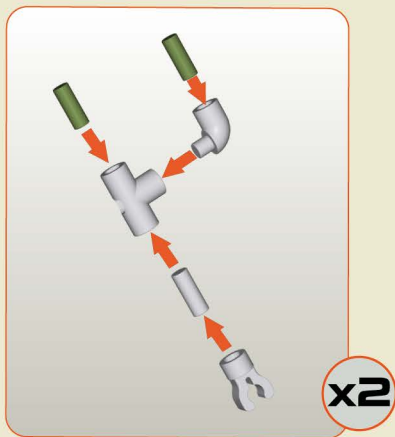

x2

x2

x2

x2

x4





x2

x2

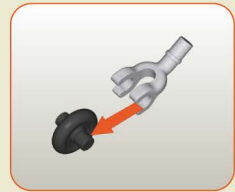
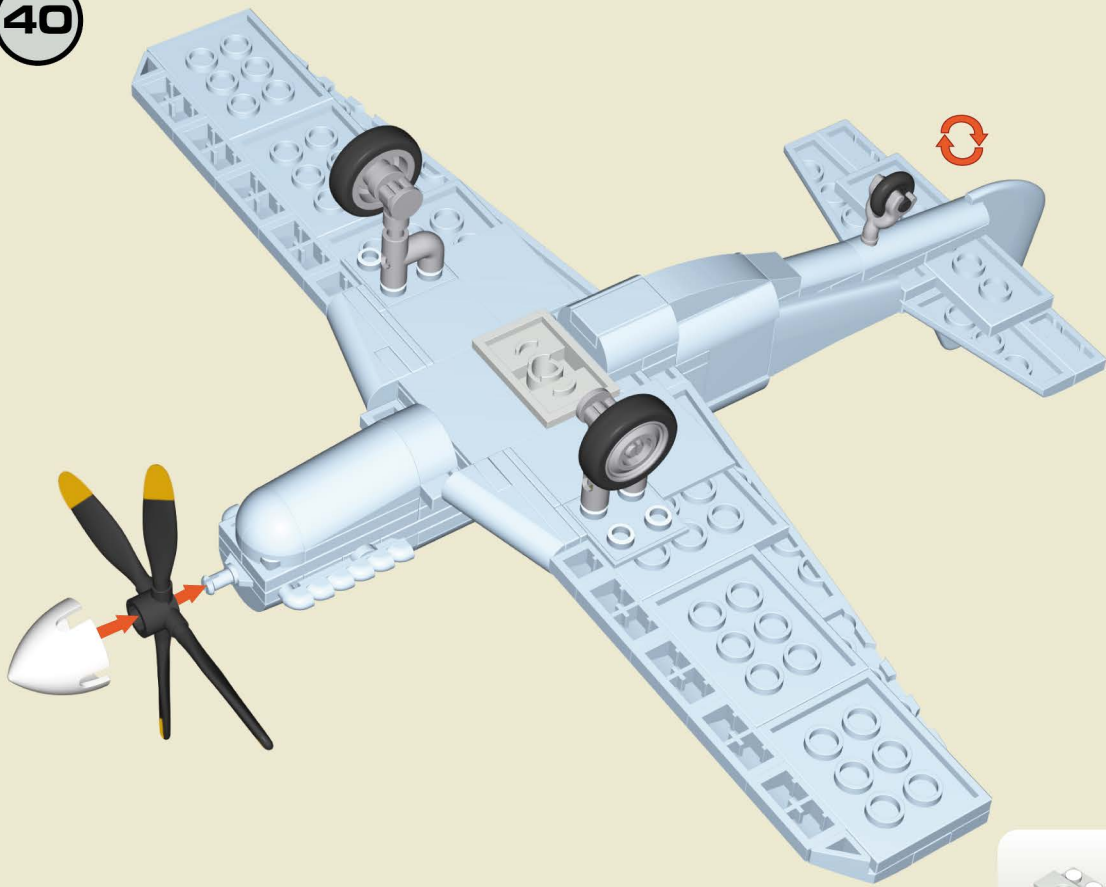
x2

40



-  **x1**
-  **x1**
-  **x1**
-  **x1**
-  **x1**



x5
44014



x1
86093



x2
147889



x2
150425



x4
92239



x2
113932



x1
95106



x1
42927



x4
42931



x1
92647



x1
161966



x1
42909



x1
92649



x2
134976



x3
45540



x1
92882



x1
137672



x1
117265



x1
42952



x1
92881



x1
143654



x1
143657



x2
128968



x2
113534



x2
98140



x1
165317



x1
160804



x1
42957



x2
42959



x7
115502



x2
157720



x1
42972



x1
165318

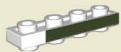

x1
165319



x1
42985



x2
64202



x1
139596



x1
83478



x1
130483



x1
43100



x1
77515



x8
121919



x2
122048



x2
126912



x1
141688



x1
141689



x4
43154



x1
165323



x1
136062



x3
120917



x1
165324



x1
153302



x1
153309



x1
165325



x2
107858



x1
43194



x1
92791



x2
108324



x1
165329



x1
163968

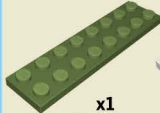

x1
43212



x4
92673



x2
92674



x6
93960



x2
155883



x1
140607



x1
165320



x1
165320



x1
165321



x1
165321



x1
165322



x1
165322



x3
99110



x1
162550



x1
140608



x2
99247



x2
138135



x1
165330



x2
99249



x2
101947



x1
58332



x4
135764



x2
131786



x1
165328



x2
92702



x1
165327



x1
160830

Customer Service

Kundenservice

Obsługa Klienta

www.cobi.eu/service

01-05860-150

For
news and
special deals

Find us on:

