

# JUMPKING<sup>®</sup>

## Trampolines

### User Guide

Made In China

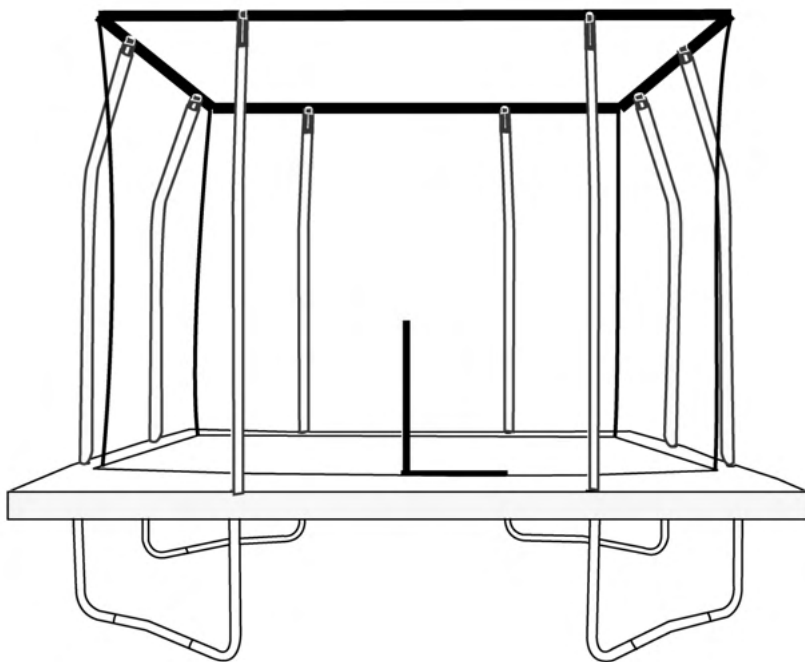

## 12ft x 17ft Rectangle Combo

**Got a Problem building your trampoline?  
Call us on 0344 800 4060 and we can help**

**Patent no: DE602006006495D1, EP1721640B1 and US7628731**



**WARNING:** Read these assembly instructions carefully before attempting to assemble or use this product. Keep this user guide in a safe place for future reference.

## IMPORTANT INFORMATION

- . WARNING! ADULT SUPERVISION & GUIDANCE REQUIRED AT ALL TIMES.
- . Recommended age 6+ years.
- . No somersaults or flips - can cause serious injury.

### WARNINGS!

- . Only for domestic use.
- . Maximum user weight limit 120 kg.
- . Not suitable for children under 36 months - small parts, choking hazard.
- . Outdoor use only.
- . The trampoline should be assembled by an adult in accordance with assembly instructions and checked in every instance before use.
- . Only one user. Collision hazard.
- . Always close the net opening before jumping.
- . Remove footwear before jumping on the trampoline.
- . Do not use the mat / jumping bed when it is wet.
- . Empty pockets and hands before jumping.
- . Always jump in the middle off the mat / jumping bed.
- . Do not eat whilst jumping.
- . Do not exit by a jump.
- . Limit the time of continuous usage (make regular stops).
- . Do not use in strong wind conditions and secure the trampoline.
- . The net should be replaced every 1 year.

### ADVISORY

- . This trampoline is not intended to be buried in the ground.
- . The following product dimension relate to this trampoline:
  - Height from ground to top rail: 89 cm (0.89m)
  - Height from ground to top of enclosure: 278 cm (2.78m)
  - Height from top rail to top of enclosure: 189 cm (1.89m)
- . The trampoline must be placed on a level surface at least 2m from any structures or obstructions such as fence, garage, house, overhanging branches, laundry lines or electrical wires.
- . Do not install the trampoline over concrete, asphalt or any other hard surface not at proximity of other conflicting installation, such as paddling / swimming pools, swings, slides or climbing frames.
- . Inspect trampoline / enclosure net before each use. Any damaged or worn parts must be replaced before using the trampoline (*see spare parts page 19*).
- . If an access ladder is used it should be removed when trampoline is not in use.
- . Make sure there are no children / animals / obstructions underneath the trampoline.
- . Access the trampoline through the door of the enclosure net only. Making sure you securely close it before bouncing.
- . Please don't use when it's windy or rainy as this can cause you slip and become injured.
- . Don't intentionally rebound off the enclosure net as this will weaken it.
- . Only attach manufacturer approved accessories to the trampoline and enclosure net.
- . Always jump in the middle of the mat and practice bounce techniques safety with adult supervision and guidance.
- . Jump without shoe.
- . In certain countries during winter period, the snow load and the very low temperature can damage the trampoline. It is recommended to remove the snow and store the mat and the enclosure indoor.

## IMPORTANT PRECAUTIONS



- Do not land on your head or neck.
- Paralysis or death can result, even if you land in the middle of the jumping surface.
- To reduce the chance of landing on your head or neck, do not do somersaults (flips).
- Avoid bouncing when tired.



- Only **1 user** allowed at any one time.
- Multiple jumpers increase the chances of loss of control, collision and falling off. This can result in serious injury to head, neck, arms or legs.

## JUMPING INSTRUCTIONS

### Fundamental Bounce

1. Start from a standing position with your head erect and your eyes on the frame pad.
2. Swing your arms forward and up in a circular motion.
3. Bring your feet together and point your toes downward while in the air.
4. Keep your feet about 30 cm (15 in.) apart from when landing on the bed.

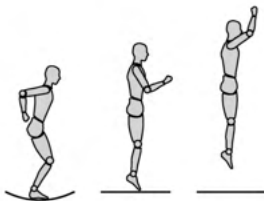

### Knee Drop

1. Start bouncing from a standing position, keeping your eyes on the frame pad.
2. Land on your knees, keeping your back straight and your body erect.
3. Come back up to an erect position.

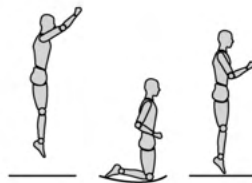

### Hand and Knee Drop

1. Start bouncing from a standing position, keeping your eyes on the frame pad.
2. Land on the bed on your hands and knees.
3. Push with your hands and come back up to an erect position.

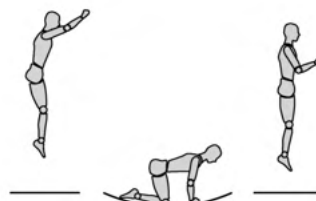

### Seat Drop

1. Land in a sitting position with your legs parallel to the bed.
2. Place your hands on the bed beside your hips.
3. Push with your hands to return to an erect position.

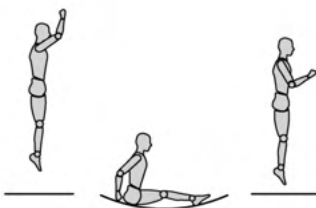

### Half Turntable

1. Start from the front drop position and push to the left or right with your arms to begin turning your body in the opposite direction.
2. Turn your head and shoulders toward the direction that your body is turning.
3. Keep your back parallel to the bed and your head up.
4. After completing a half turn, land in the front drop position.

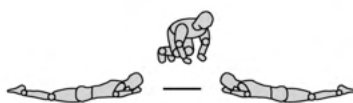

### Swivel Hips

1. Start with a seat drop.
2. Turn your head to the left or right and swing your arms up in the same direction.
3. Turn your hips in the same direction as your head and arms, completing a twist.
4. Land in the seat drop position.

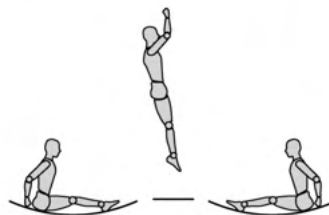

## CARE & MAINTENANCE

Regular care and maintenance of your trampoline is required. This will help prolong its life and reduce the possibility of injury. Neglecting this can lead to a risk for users.

Inspect your trampoline before each use using the checklist below as a guide. Take particular care in doing this at the start of each season and at regular intervals. Ensure all parts are in tact and cannot become dislodged during play, tighten any screws or nuts and bolts where required.

**IMPORTANT:** If any faults are found, the trampoline **MUST NOT BE USED**. We advise that the trampoline is dismantled and placed in a dry place until new parts are fitted.

| PART   | CHECKLIST   | OK | NOT OK |
|--|---|----|--------|
| All Parts                                    | Securely attached                                     |    |        |
|  | Correctly positioned                                  |    |        |
|  | No sharp edges or points present                      |    |        |
|  | No missing parts                                      |    |        |
| Springs                                      | No damage ( <i>bent / broken</i> )                    |    |        |
|  | No missing parts                                      |    |        |
| Frame / Enclosure Poles                      | No bent parts   |    |        |
|  | No damage   |    |        |
|  | No rusting or corrosion                               |    |        |
| Bed / Enclosure Net / Frame Pad / Foam Tubes | No missing parts<br>(e.g. V-rings / Ties / Zips etc.) |    |        |
|  | No sagging  |    |        |
|  | No damage<br>(Holes / Rips / Fraying / Tearing)       |    |        |

### Looking after your trampoline:

- **Use trampoline as advised on pages 2-3.** Excess weight and improper use will damage it and cause it to break easily.
- **Keep trampoline clean.** If any part becomes dirty, clean with a damp cloth and dry thoroughly. Do not use any abrasive cleaners as this could damage the product.
- **Store enclosure net and frame pad in a dry place when not in use.** Prolonged exposure to sun and harsh weather can shorten its life.
- **Keep bed in good condition by protecting it with a cover** (*available to buy from our website*). Common damage can be caused by water pooling, garden/outdoor debris landing on it, sparks from nearby bonfires or firework displays landing on it.
- **Keep animals/pets away from the trampoline,** their claws can damage it.
- **Protect from high winds.** A trampoline can act like a sail in strong winds. It can be blown over which can cause damage to the frame and surrounding areas. We recommend that it is moved to a sheltered location and secured to the ground (*tie-down kit available from our website*), or dismantled and stored away.
- **Dismantle and store away in a dry place if not being used for long periods.** Follow assembly instructions in reverse order making sure the springs are removed before dismantling frame.
- **Take care when moving trampoline.** To be lifted by 2 people. Lift slightly off the ground, keeping the frame horizontal. Never drag to move it as this can displace parts. Always check that parts are positioned correctly after moving.

## BUILDING YOUR TRAMPOLINE

1. This is a 2 person build.
2. Time for build is approximately 2 hours.
3. Choose a good location:
  - On a level surface that is soft (*wood chippings, sand or grass*).
  - Ensure adequate overhead clearance. A minimum of 24ft (7.3m) from ground level, away from wires, trees and other possible hazards.
  - Ensure a clear space of 8.2ft (2.5m) around sides, away from walls, fences, structures, tarmac and other hard surfaces and play areas.

## WHAT YOU WILL NEED

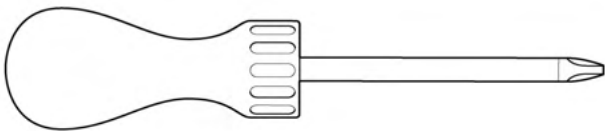

Description:  
**Cross-head screwdriver**

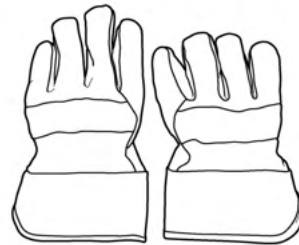

Description:  
**Gloves**

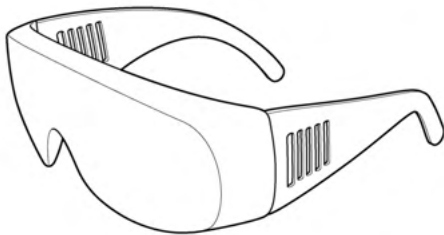



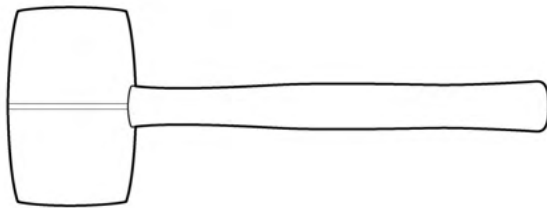















Description:  
**Safety glasses**

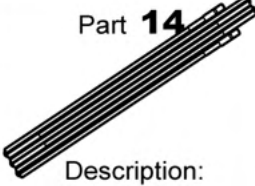
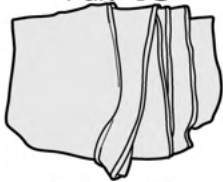
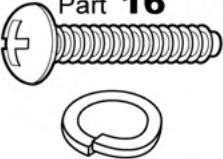
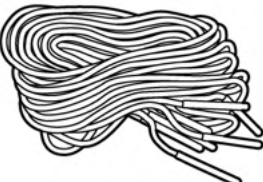

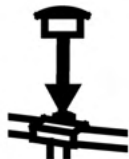
Description:  
**Mallet**

# PARTS LIST

|   |   |   |   |   |
|---|---|---|---|---|
| <p>Part <b>1</b></p>  <p>Description:<br/><b>L-Top tube<br/>D marking</b></p> <p>Quantity: <b>2</b></p>  | <p>Part <b>2</b></p>  <p>Description:<br/><b>L-Top tube<br/>A marking</b></p> <p>Quantity: <b>2</b></p>  | <p>Part <b>3</b></p>  <p>Description:<br/><b>Top tube<br/>2 pcs B 2 pcs C<br/>9 spring holes</b></p> <p>Quantity: <b>4</b></p> | <p>Part <b>4</b></p>  <p>Description:<br/><b>Top Tube<br/>C marking<br/>9 spring holes</b></p> <p>Quantity: <b>2</b></p>                         | <p>Part <b>5</b></p>  <p>Description:<br/><b>Top Tube<br/>D marking<br/>9 spring holes</b></p> <p>Quantity: <b>2</b></p>           |
| <p>Part <b>6</b></p>  <p>Description:<br/><b>Top Tube<br/>D, A marking<br/>10 spring holes</b></p> <p>Quantity: <b>2</b></p>                                   | <p>Part <b>7</b></p>  <p>Description:<br/><b>Centre legs</b></p> <p>Quantity: <b>4</b></p>   | <p>Part <b>8</b></p>  <p>Description:<br/><b>L Legs</b></p> <p>Quantity: <b>8</b></p>  | <p>Part <b>9</b></p>  <p>Description:<br/><b>7inch Springs</b></p> <p>Quantity: <b>128</b></p>   | <p>Part <b>10</b></p>  <p>Description:<br/><b>Stitched bed</b></p> <p>Quantity: <b>1</b></p>                                       |
| <p>Part <b>11</b></p>  <p>Description:<br/><b>Frame pad</b></p> <p>Quantity: <b>1</b></p>   | <p>Part <b>12</b></p>  <p>Description:<br/><b>Bottom enclosure<br/>poles</b></p> <p>Quantity: <b>8</b></p>   | <p>Part <b>13</b></p>  <p>Description:<br/><b>Top enclosure poles</b></p> <p>Quantity: <b>8</b></p>                            | <p>Part <b>14</b></p>  <p>Description:<br/><b>Black G3 poles</b><br/>Quantity: <b>4</b><br/><b>2 x Long Sections<br/>2 x Short Sections</b></p> | <p>Part <b>15</b></p>  <p>Description:<br/><b>Enclosure netting</b></p> <p>Quantity: <b>1</b></p>                                 |
| <p>Part <b>16</b></p>  <p>Description:<br/><b>Self tapping screws<br/>and spring washers</b></p> <p>Quantity: <b>24</b></p>                                  | <p>Part <b>17</b></p>  <p>Description:<br/><b>Cords</b></p> <p>Quantity: <b>8</b></p>  | <p>Part <b>18</b></p>  <p>Description:<br/><b>Spring tool</b></p> <p>Quantity: <b>1</b></p>                                  | <p>Part <b>19</b></p>  <p>Description:<br/><b>Cap connector</b></p> <p>Quantity: <b>8</b></p>  | <p>Part <b>20</b></p>  <p>Description:<br/><b>10mm Screws</b></p> <p>Quantity: <b>4</b><br/>2 pcs pre-assemble<br/>on frame.</p> |
| <p>Part <b>21</b></p>  <p>Description:<br/><b>T-Connector +<br/>welded tube</b><br/><b>2 pcs A 2 pcs B<br/>2 pcs C 2 pcs D</b></p> <p>Quantity: <b>8</b></p> | <p>Part <b>22</b></p>  <p>Description:<br/><b>G3 L Steel Connector<br/>(Have been attached to<br/>the G3 poles Part L)</b></p> <p>Quantity: <b>4</b></p> | <p>Part <b>24</b></p>  <p>Description:<br/><b>5.5inch Springs</b></p> <p>Quantity: <b>8</b></p>                              |   |   |

# STEP 1 : ASSEMBLING THE FRAME

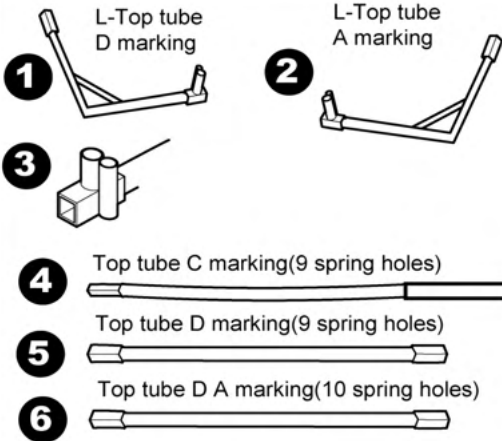

You will need the following parts to complete section 1:

- 2 x Part 1 & 21: L tube with D marking
- 2 x Part 2 & 21: L tube with A marking
- 4 x Part 3 & 21: Top tube with T-connector+welded tube (2xB, 2xC)
- 2 x Part 4: Straight tube with C marking(9 spring holes)
- 2 x Part 5: Straight tube with D marking(9 spring holes)
- 2 x Part 6: Straight tube A D marking(10 spring holes)
- 4 x Part 7: Centre leg
- 8 x Part 8: L Leg
- 16 x Part 16: Self tapping screw + washers

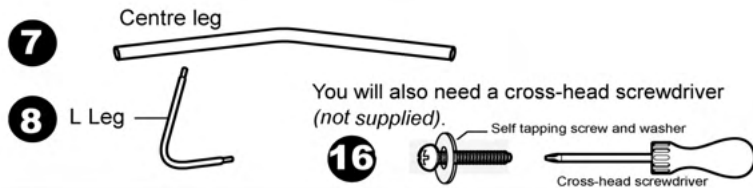

Top tube C marking(9 spring holes)

Top tube D marking(9 spring holes)



Slot the narrow end of the top tube with T-connector.

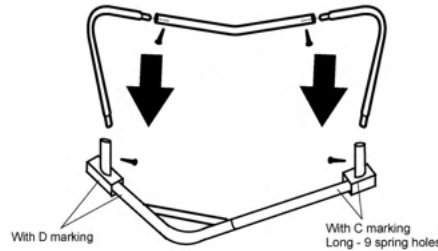
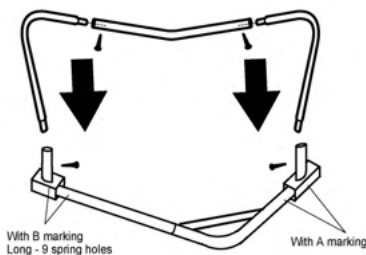

Place Part 1 - L tube upside down and attached Part 3 T-connector+welded tube with D marking to the long end join Part 4 top tube with C marking(9 spring holes) to the short end and attach Part 3 - T-connector+welded tube with C marking.  
N.B.: The letters on the welded tube will facing outwards and the welded tube positioned on the inside frame. Screw holes on T-connector+welded tubes facing towards one another.

Place Part 2 - L tube upside down and attach Part 3 T-connector+welded tube with A marking to the long end join Part 5 top tube with B marking(9 spring holes) to the short end and attach Part 3 - T-connector+welded tube with B marking.

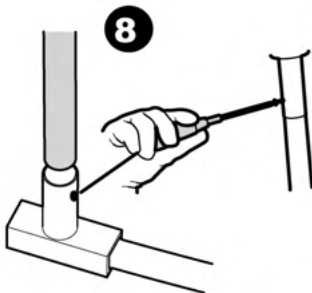

Insert the center leg and leg extensions into upright tube on T-connector.

Note: You may need to tap the leg extension in using a rubber mallet or by placing a piece of wood over the top of the tube. Do not use a metal hammer on the metal tube as this may distort the end of tube.

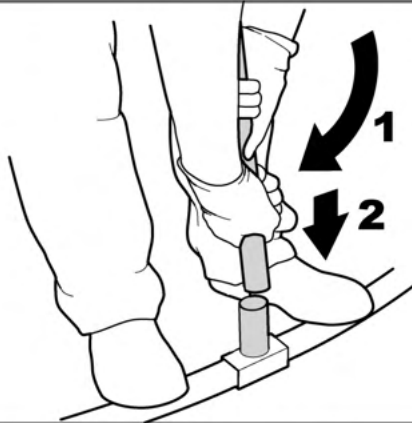

**Important:** The frame is held together under tension so you will have to use some force to insert certain parts.

Place your feet on the top tubes and grip the leg extension with both hands.

Pull the extension until it can be slotted into the T-connector.

Slot the end of leg extension into the T-connector.

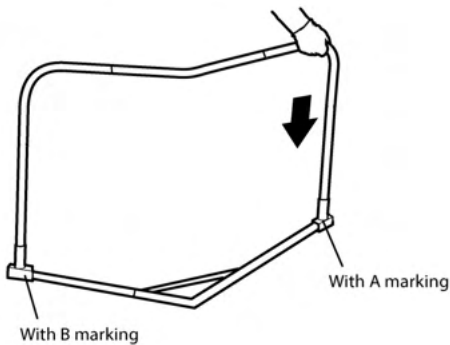

Push down on the end of the centre leg to fully inset the leg extension into the T-connector.

Screw one of the self tapping screws through the slot in the T-connector and into the hole in the leg extension using the cross-head screwdriver.

You have now completed the first frame section.

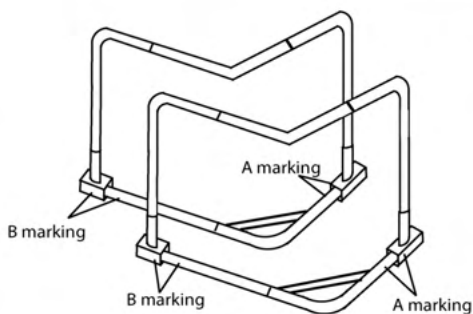
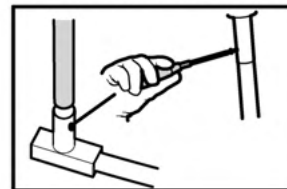

Repeat the last two steps until you have assembled the remaining sections of the trampolines frame.

You have now completed step.

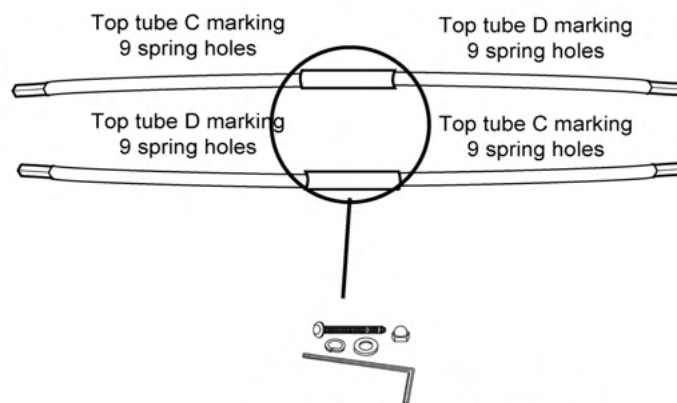
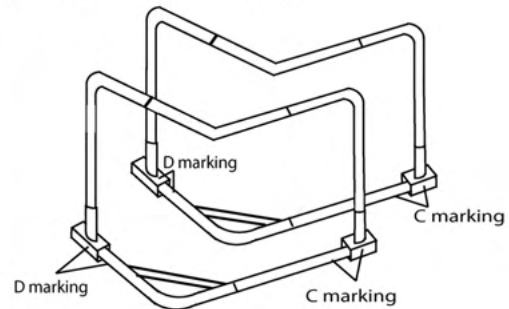

Tighten with 10mm screws - Part 20



## STEP 2 : ASSEMBLING THE FRAME

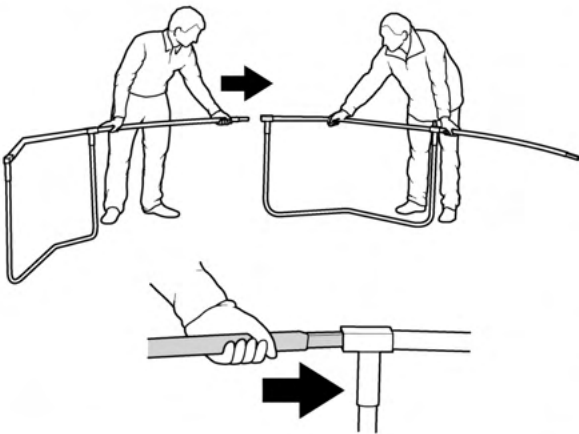

This step will require 2 people who must be wearing gloves.

Slot two of the frame section together as shown in the diagram.

Attach Part 6: top tube with A D markings (10 spring holes) in between the T-connector+welded tube marked A and D.

Attach Parts 4 and 5 the completed sections marked C, D, C between T-connector+welded tubes B and C.

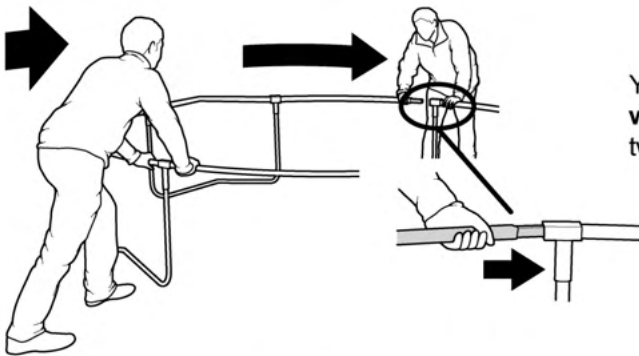

You will now need to slot the frame together, **this will take some force**. The easiest method is if the two people face each other.

Hold the top tubes either side of the T-connector+welded tubes and push towards each other until the loose end of the frame can be inserted into the T-connector.

Numbers relate to amount of spring holes on top rail.

**Important:** Ensure all of the top tubes, leg extensions and centre legs are fully inserted. Please ensure Top rail D6 is curving outwards. The frame is now fully assembled and you have now completed step 2.

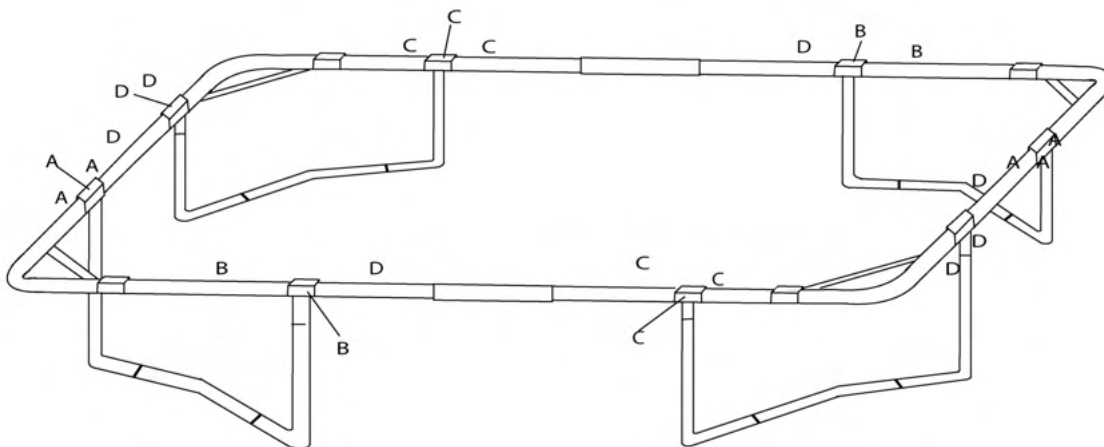

## STEP 3 : FITTING THE STITCHED BED

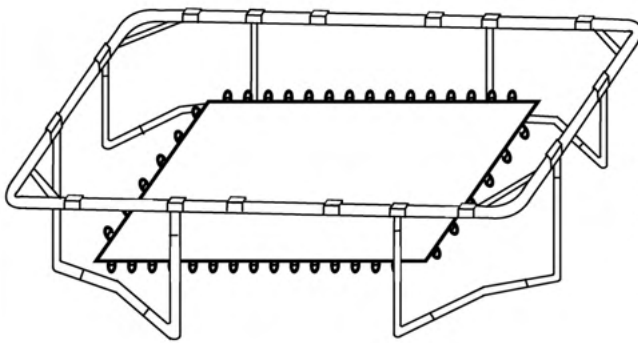

### Part 10

This step will require 2 people who must be wearing gloves and protective eye wear.

Lay the stitched bed (with the V-Rings) out inside the frame of the trampoline with the warning labels facing upwards.

Please note the bed is 2 foot smaller than the frame.

Color webbing

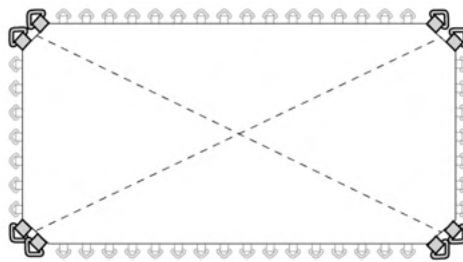

Locate the 4 corner V-rings.

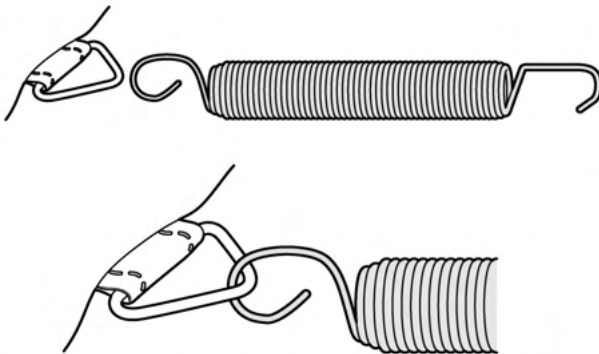

### Part 9, 18 and 24

Slot one of the 5.5" springs onto one of the V-ring as shown.

Important: springs must be slotted on the right way around with the more curled end of the spring hooked to the V-ring.

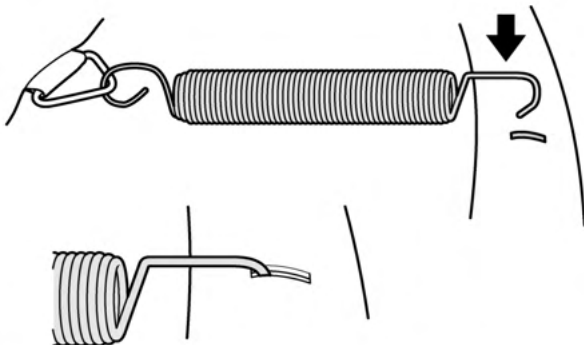

Slot the other end of the spring into one of the spring slots in the top of the frame.

**IMPORTANT: Ensure the spring is fully inserted into the slot on the top of the frame.**

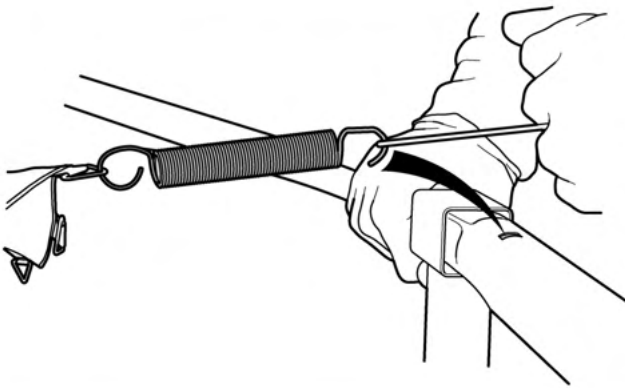

Attach a spring to the diagonal V-ring.

**Important:** You will now need to use the spring tool to attach the spring to the frame.

Hook the spring tool onto end of spring, and pull until the spring can be slotted into the spring slot on the top of the frame.

**IMPORTANT:** Ensure the spring is fully inserted into the slot on the top of the frame.

Attach four more 3.5" springs to the V-Rings then attach them to the frame next to the T-connector+welded tube.

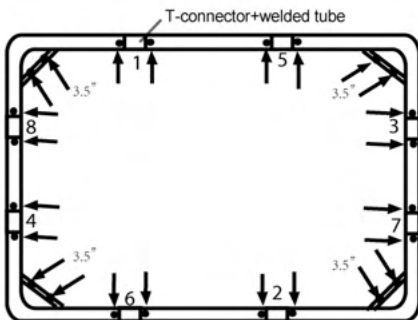

Continue to attach 7" springs to the rest of the frame in the same sequence as above: in the middle of each section, making sure the next spring is attached on the opposite side to even out the tension.

**Important:** The stitched bed is designed like elastic to be bouncy, which means that during construction it may look like it won't fit. Please note that it will stretch to the correct size when attaching the springs, this may take some force.

The stitched bed is now fitted and you have completed step 3.

## STEP 4 : FITTING THE FRAME PAD

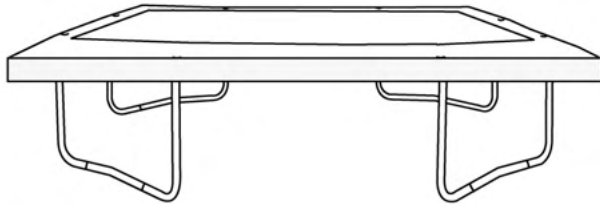

**This step will require 2 people.**

Lay the frame pad - **Part 11** out over the edge of the frame with the ties facing downwards.

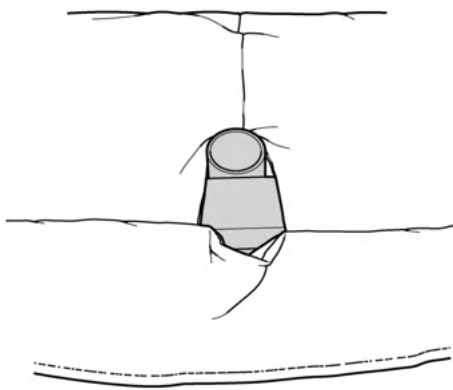

Align the openings in the frame pad with the T-connector+welded tube's on the frame.

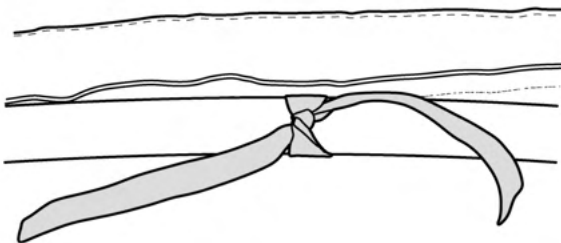

Tie the outer elastic straps on the underside of the frame pad around the top tubes of the frame.

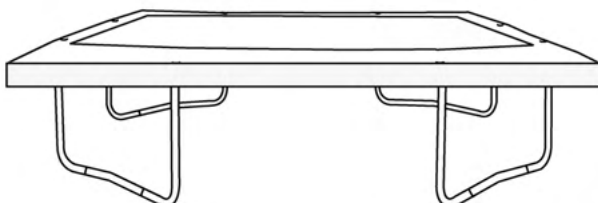

The frame pad is now fitted and you have completed step 4.

**WARNING:** The trampoline **MUST NOT** be used during construction.

## STEP 5 : FITTING THE ENCLOSURE TUBES

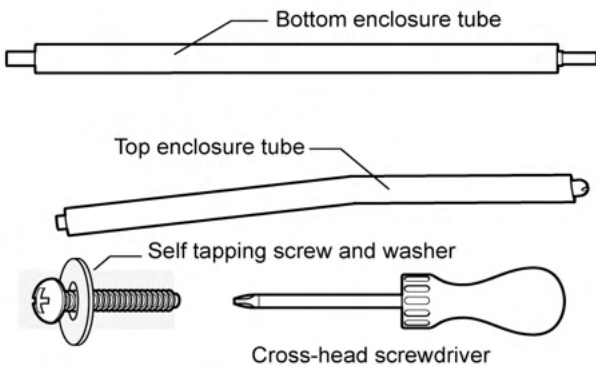

You will need the following parts to complete step 5:

8 x Bottom enclosure tubes - **Part 12**

8 x Top enclosure tubes - **Part 13**

8 x Self tapping screws & washers - **Part 16**

You will also need a cross-head screwdriver (*not supplied*).

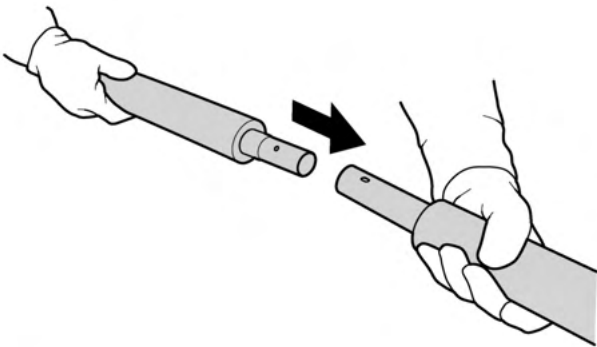

Slot the thin end of one of the bottom enclosure tubes into the open end of one of the top enclosure tubes.

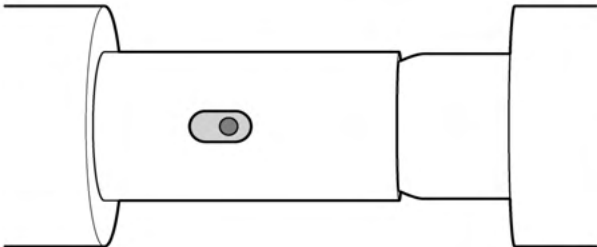

Align the hole in the bottom enclosure tube with the slot in the top enclosure tube.

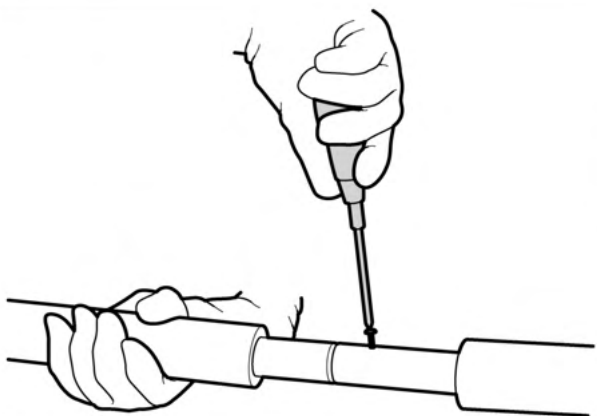

Screw one of the self tapping screws through the slot in the top enclosure tube and into the hole in the bottom enclosure tube using the cross-head screwdriver.

Please note the screw is larger than the hole. Some force will be needed to screw this in.

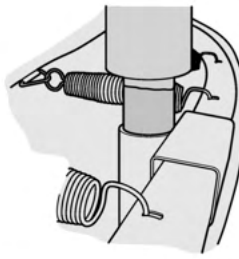
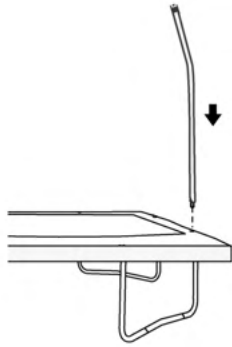

Slot the bottom enclosure tube into the tubes in the T-connector+welded tubes visible through the slots in the frame pad.

Screw one of the self tapping screws through the slot in the tubing and into hole using the cross-head screwdriver.

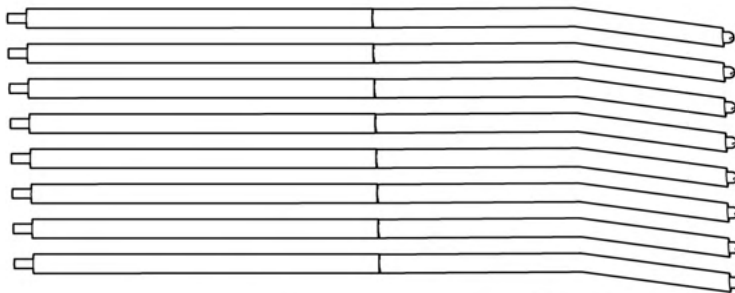

Assemble the seven enclosure tubes using the three self tapping screws and the cross-head screwdriver.

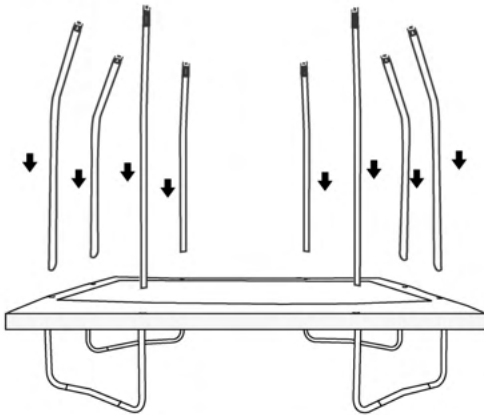

Slot the eight enclosure tubes into the T-connector+welded tube's on the frame.

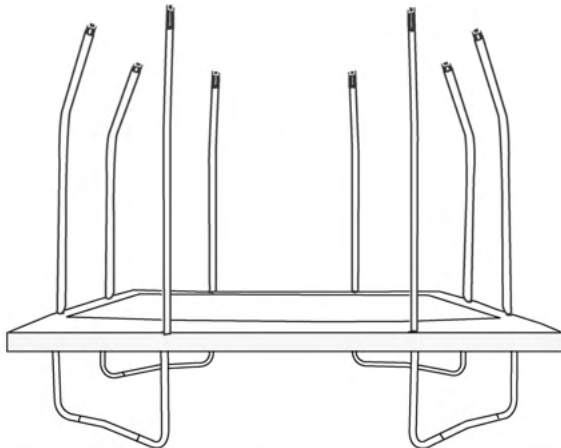

The enclosure tubes are now fitted and you have completed step 5.

## STEP 6 : FITTING THE ENCLOSURE NETTING

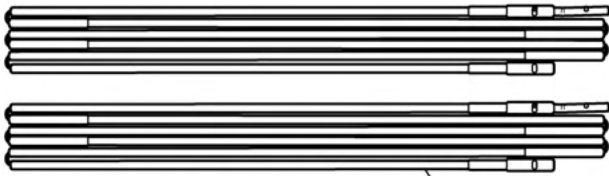

Black G3 poles

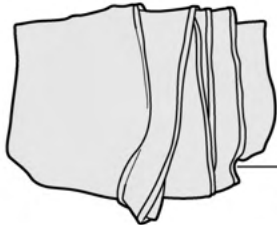

Enclosure netting

You will need the following parts to complete step 6:

2 x Black G3 poles - **Part 14 and 22**  
(2 x Long Sections, 2 x Short Sections)

1 x Enclosure netting - **Part 15**

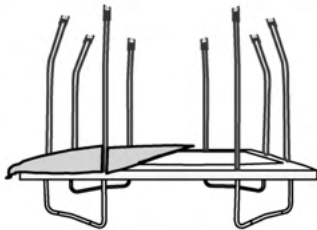

Lay the enclosure netting out on the trampoline.

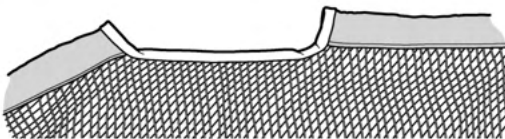

Find the sleeves that run along the top of the enclosure netting.

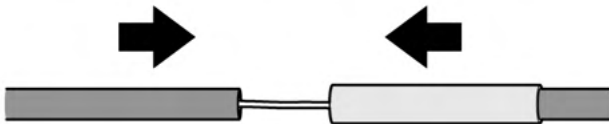

Slot the thin sections on the two black G3 poles into the metal ends so the poles become two long sections.

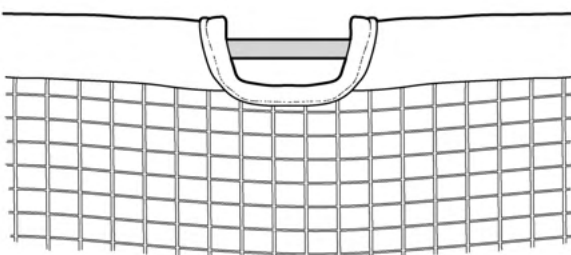

You may need to slide the connected poles around in the nettings sleeves until the thin black sections are aligned with the gaps between sleeves.

The corners of the G3 rod jut out of a long cut out section of the netting.

The zip of the door is on the long side of the trampoline.

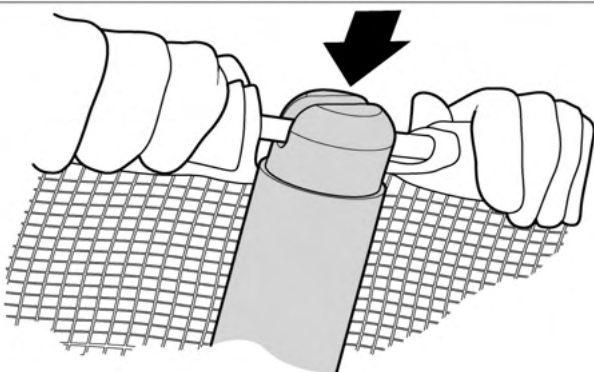

With the netting hanging on the inside of the enclosure poles, stand on the trampoline and insert one of the exposed sections of the Black G3 pole into a plastic grip on top of one of the enclosure tubes.

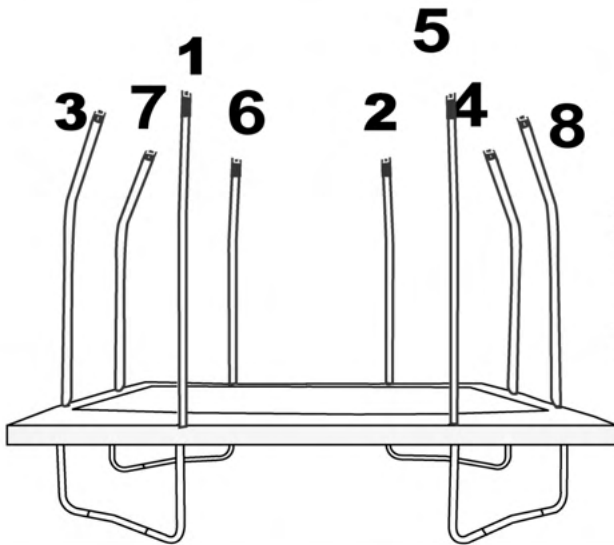

Attach the seven other exposed sections of the FRP rods to the other enclosure tubes in the order shown in the diagram.

Ensuring the four corners of the FRP rods are in the exposed sections.

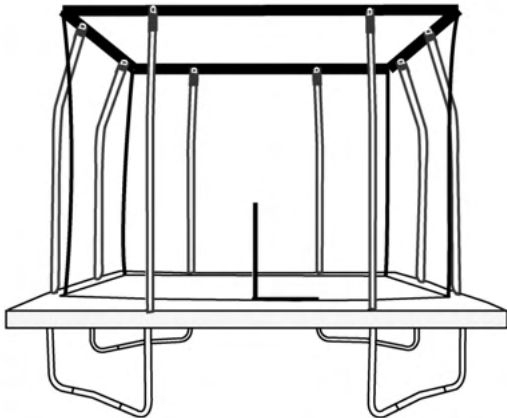

The enclosure net is now fitted and you have completed step 6.



## STEP 7 : ATTACHING THE BOTTOM OF THE NET

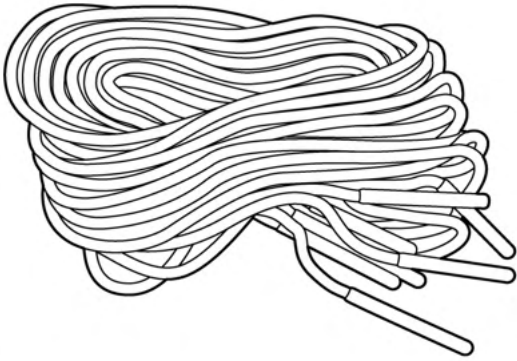

You will need the following parts to complete step 7:  
8 x Cords - **Part 17**.

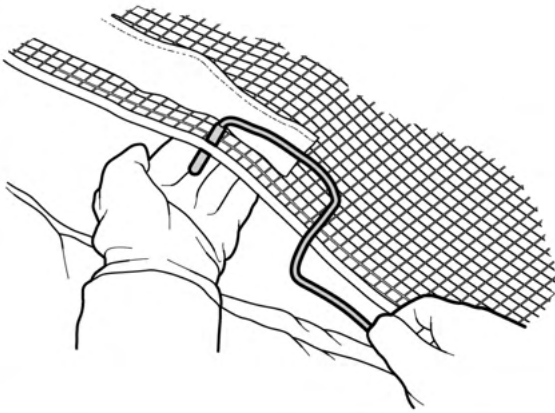

Tie one end of the cord around a V-ring on the bed of the trampoline. Push the outer end through a hole in the bottom of the netting. Sew in and out using every V-ring and a hole in the netting nearest that V-ring.

**Important:** Keep the cord tight at all times.

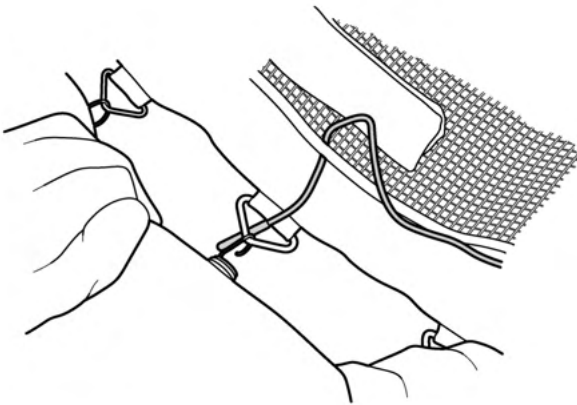

Continue to do this until all the net is sewn in, tying off the rope and starting the next when it has come to the end.

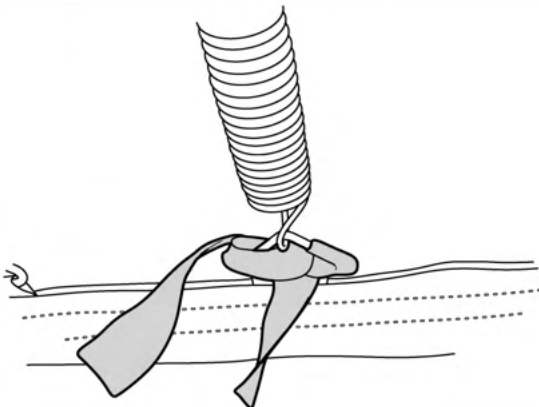

From the underside of the trampoline, tie the remaining elastic straps around the springs or through the V-Rings.

You have completed step 7 and the trampoline is fully assembled.

## USING THE TRAMPOLINE

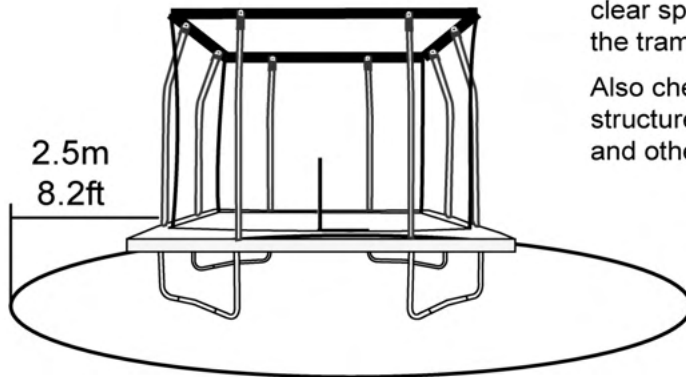

Before using your trampoline, check again that there is enough clearance around it. Maintain a clear space of 2.5 metres (8.2 feet) on all sides of the trampoline.

Also check that the area is free from walls, structures, fences, tarmac and other hard surfaces and other play areas.

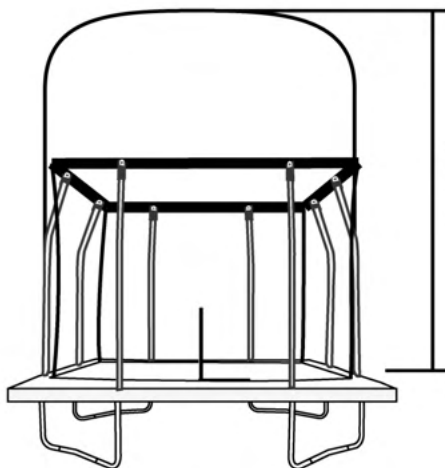

7.3m 24ft Ensure that there is 7.3 metres (24 feet) clearance above the trampoline.

Also check that there are no overhanging objects in the area above the trampoline.

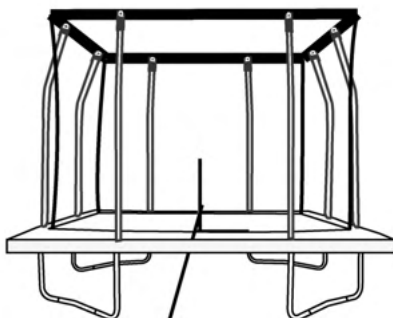

Door zip

To enter the trampoline, unzip the door and climb in.

Always close the doorway before using the trampoline.

N.B.: The zip will be on the long side of the trampoline.

# SPARE PARTS

To order replacement parts, you can email us on: [customerservice@yjeurope.co.uk](mailto:customerservice@yjeurope.co.uk), or call our Customer Helpline on: 0344 800 4060.

To help us assist you, please provide the following information when calling:

- The PRODUCT DESCRIPTION: **12' x 17' Rectangle Combo (JKR1217GV2)**
- The KEY No. and DESCRIPTION of the part (see parts list below).
- The quantity needed.

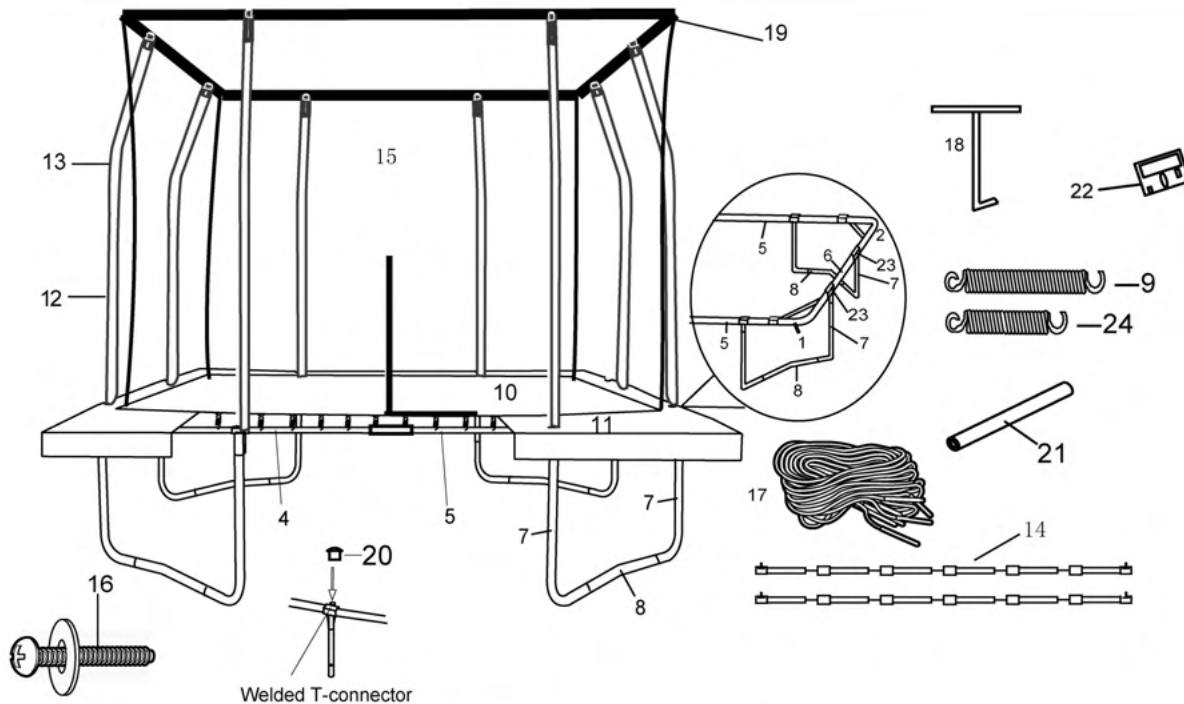

| Key No. | Qty. | Description  | Key No. | Qty. | Description                                     |
|---------|------|--|---------|------|---|
| 1       | 2    | L Frame with D marking                               | 9       | 128  | 7" springs                                      |
| 2       | 2    | L Frame with A marking                               | 10      | 1    | Bed   |
| 3       | 4    | Straight tube with B & C marking<br>(9 spring holes) | 11      | 1    | Surround pad                                    |
| 4       | 2    | Straight tube with C marking<br>(9 spring holes)     | 12      | 8    | Bottom enclosure poles                          |
| 5       | 2    | Straight tube with D marking<br>(9 spring holes)     | 13      | 8    | Top curved enclosure poles                      |
| 6       | 2    | Straight tube with A D marking<br>(10 spring holes)  | 14      | 1    | G3 Rod - 2 in pack                              |
| 7       | 8    | L leg  | 15      | 1    | Net   |
| 8       | 4    | Centre leg   | 16      | 1    | Self tapping screws pack of 24                  |
|         |      |  | 17      | 1    | Ropes - 8 in pack                               |
|         |      |  | 18      | 1    | Spring tool                                     |
|         |      |  | 19      | 8    | Enclosure plastic cap                           |
|         |      |  | 20      | 8    | Connector cap                                   |
|         |      |  | 21      | 16   | Foam sleeve                                     |
|         |      |  | 22      | 1    | User Manual                                     |
|         |      |  | 23      | 8    | T-connector+welded tube<br>(Ax2, Bx2, Cx2, Dx2) |
|         |      |  | 24      | 8    | 5.5" Springs                                    |

For a full range of accessories and replacement parts call 0344 800 4060 or visit our web site at: [www.jumpking.eu](http://www.jumpking.eu)