









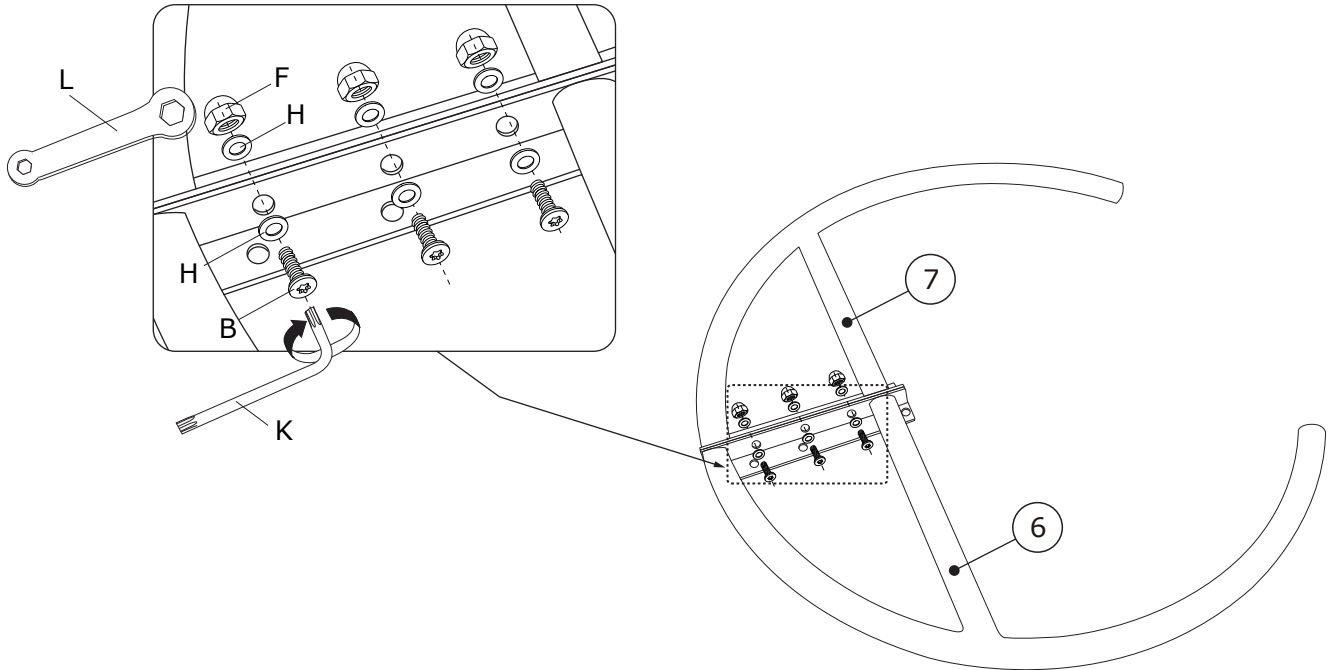

1

<p>B x 3</p>  <p>M8x20 mm</p>	<p>F x 3</p>  <p>M8/13 mm</p>	<p>H x 6</p>  <p>Ø8/Ø16 mm</p>	<p>K x 1</p>  <p>T25</p>	<p>L x 1</p>  <p>10/13 mm</p>	
--	--	---	---	--	--



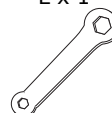



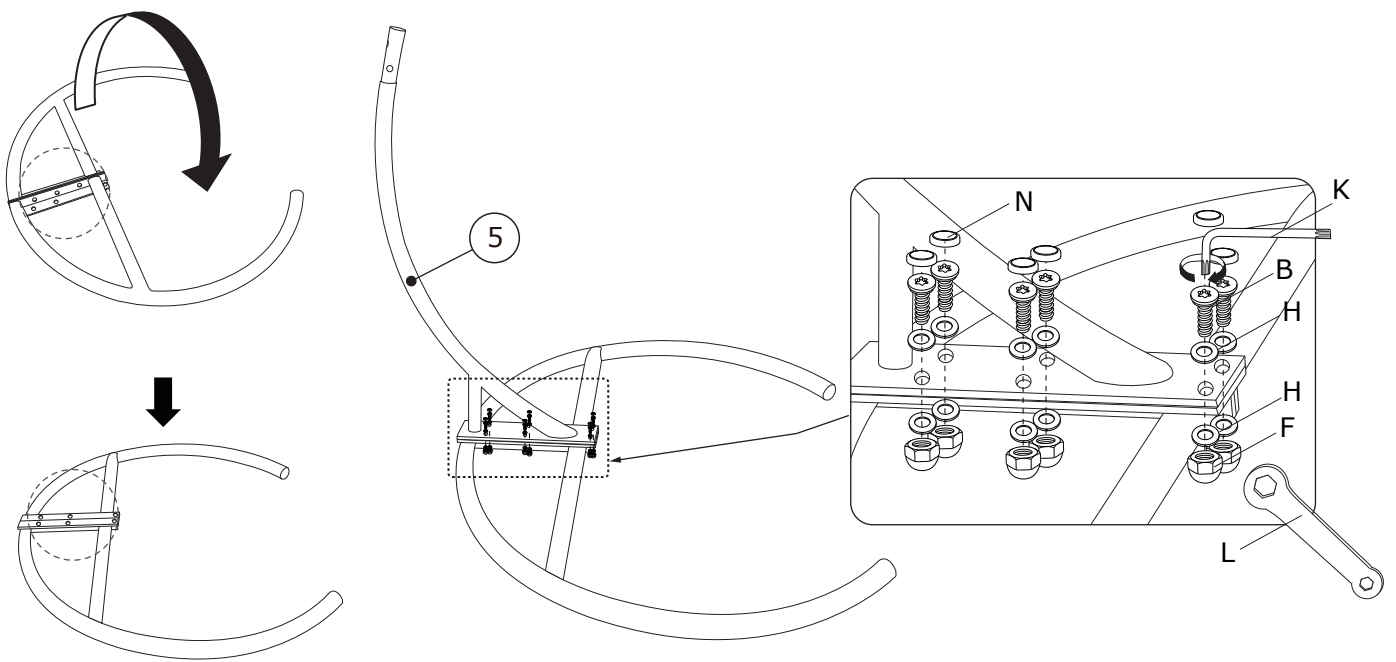

2

<p>B x 6</p>  <p>M8x20 mm</p>	<p>F x 6</p>  <p>M8/13 mm</p>	<p>H x 12</p>  <p>Ø8/Ø16 mm</p>	<p>K x 1</p>  <p>T25</p>	<p>L x 1</p>  <p>10/13 mm</p>	<p>N x 6</p>  <p>Ø16 mm</p>	
--	--	--	---	--	--	--





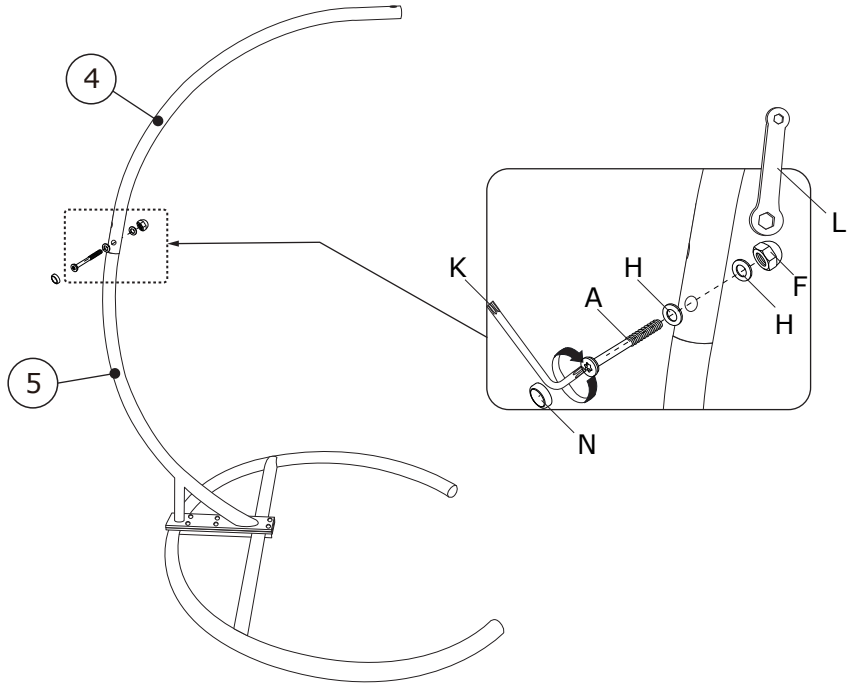

3

A x 1  M8x50 mm	F x 1  M8/13 mm	H x 2  Ø8/Ø16 mm	K x 1  T25	L x 1  10/13 mm	N x 1  Ø16 mm	
--	--	---	---	--	--	--



4

B x 1  M8x20 mm	H x 1  Ø8/Ø16 mm	M x 1  Ø8/Ø13 mm	K x 1  T25	N x 1  Ø16 mm	
--	---	---	---	--	--

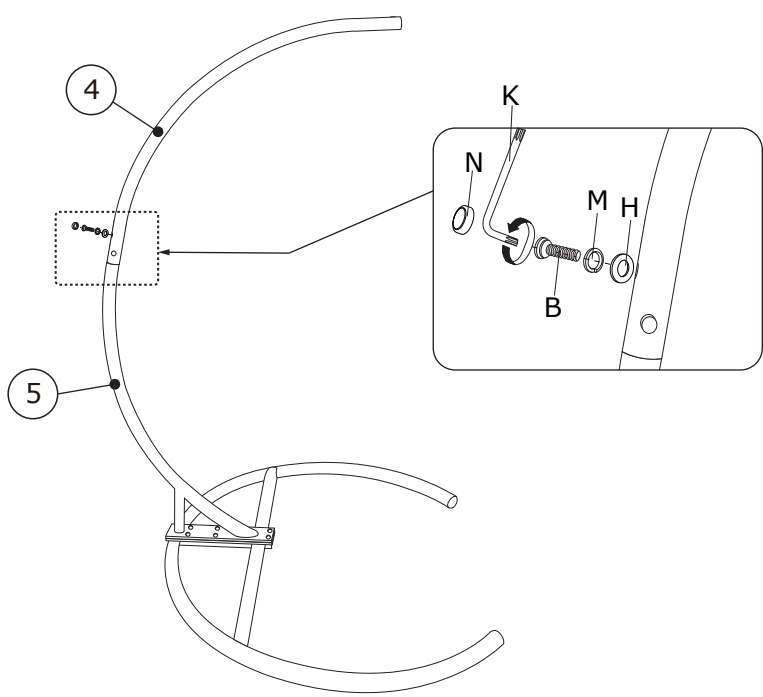

5

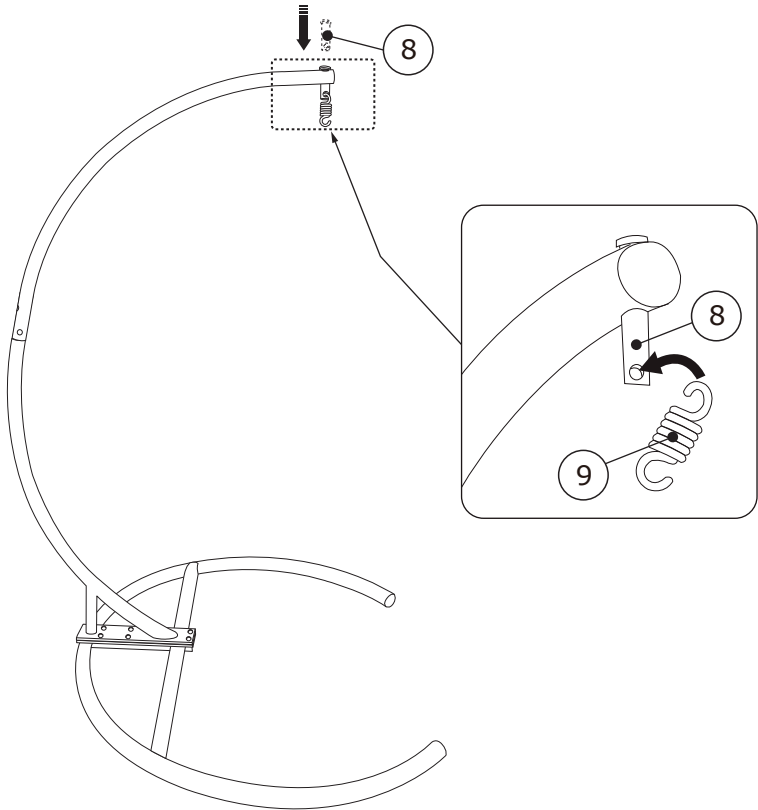



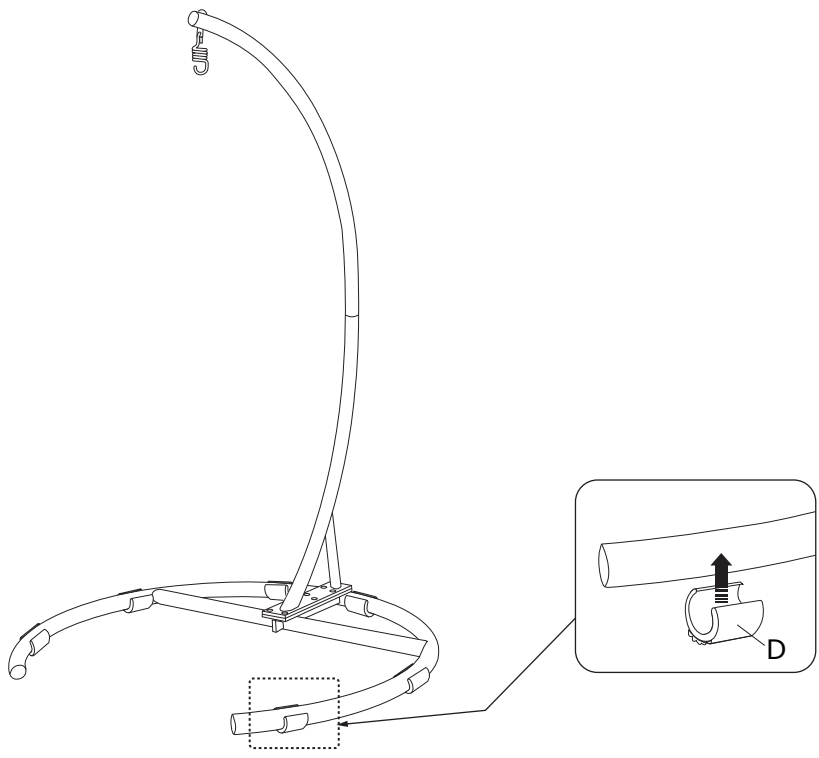

6

D x 6	
	
49x45x27 mm	

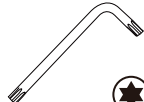

7

C x 10  M6x45 mm	G x 10  M6/10 mm	J x 20  Ø6/Ø14 mm	K x 1  T25	L x 1  10/13 mm	
---	---	--	---	--	--

80%

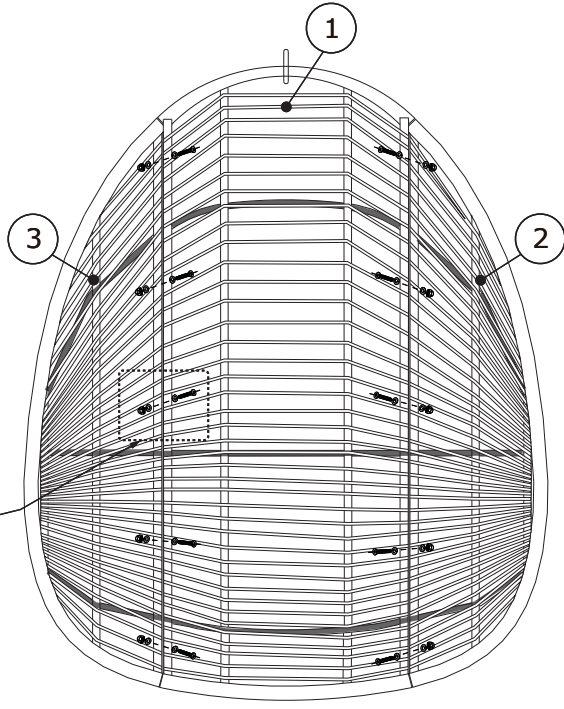
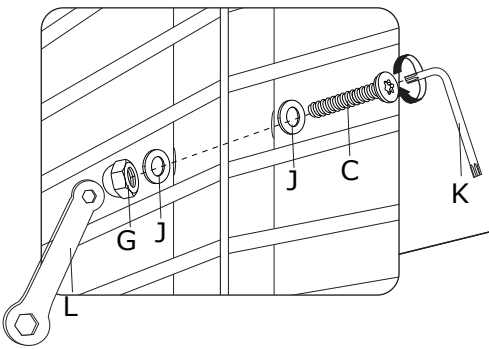
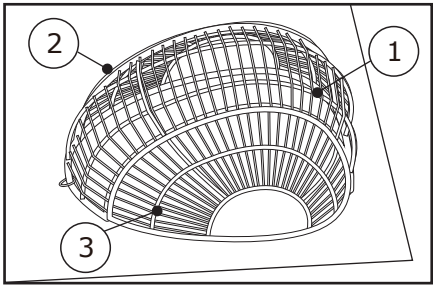

8

K x 1  T25	L x 1  10/13 mm	
---	--	--

100%

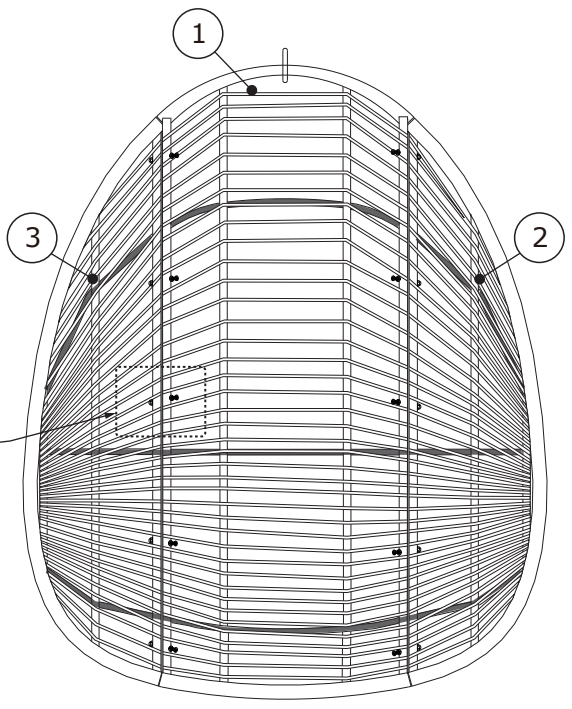
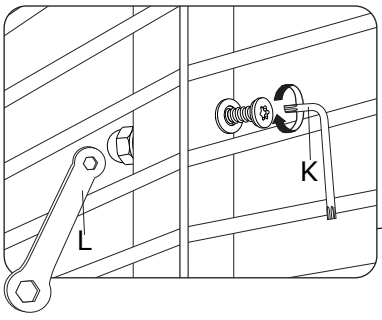

9

N x 10



Ø16 mm

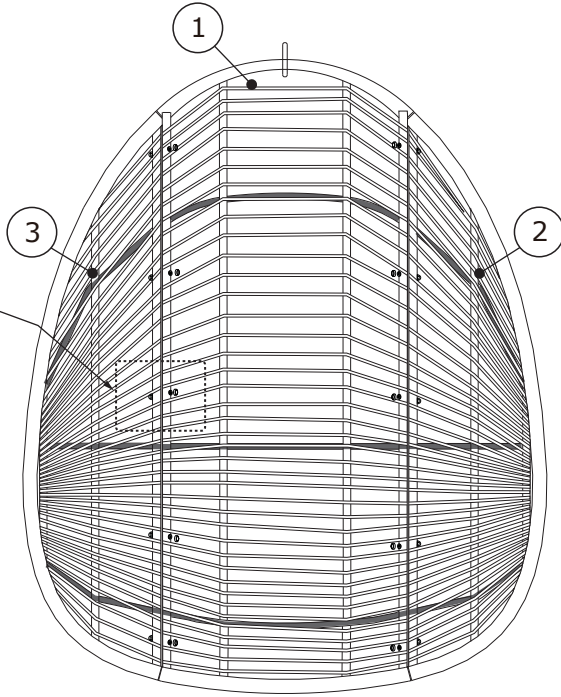
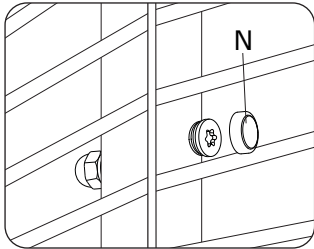

10

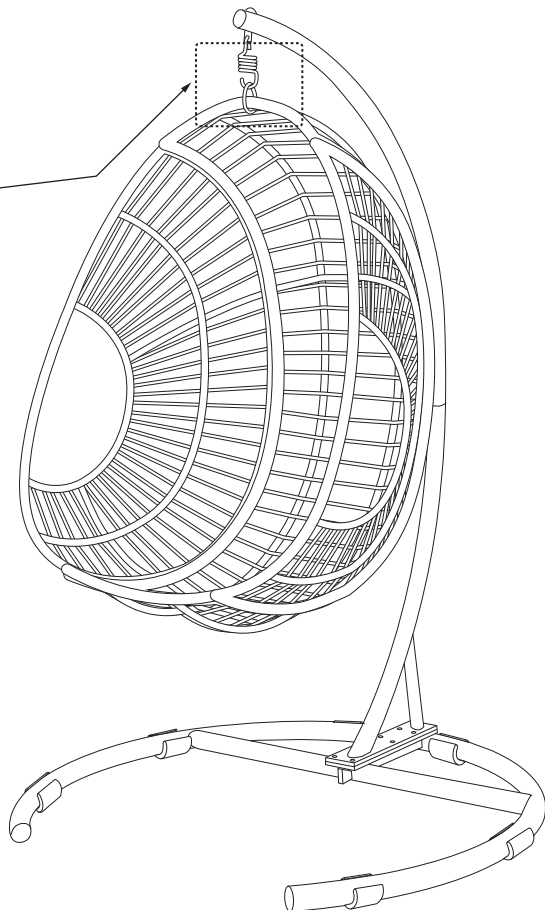
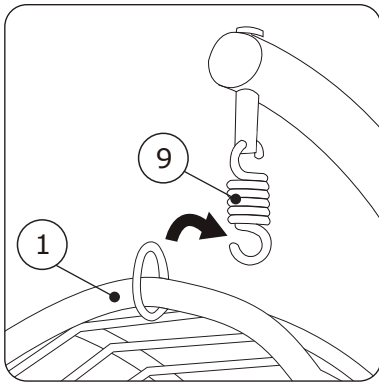

11

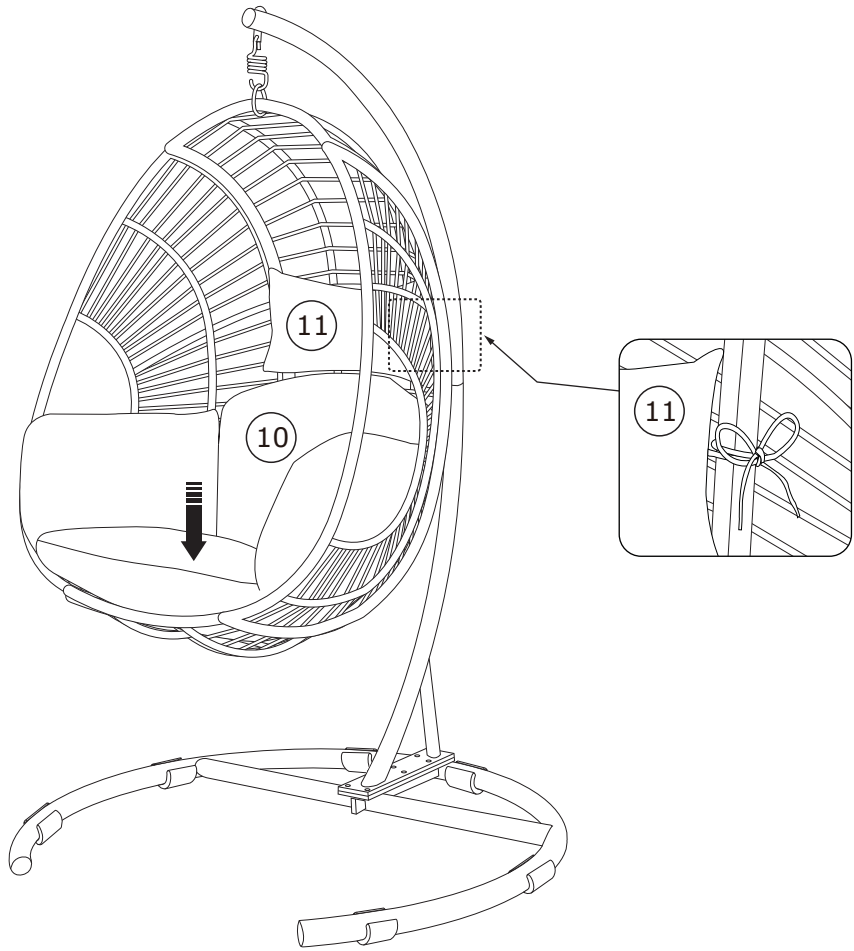

12

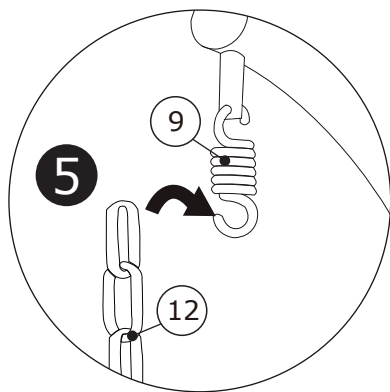
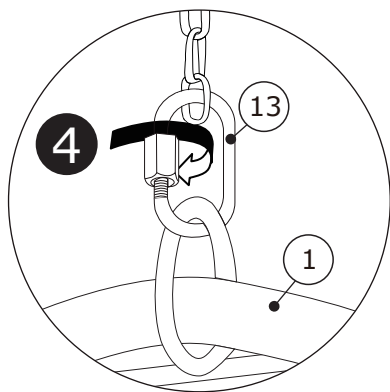
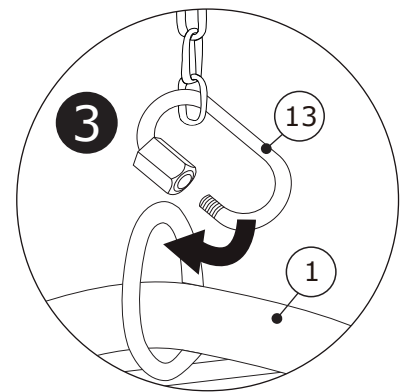
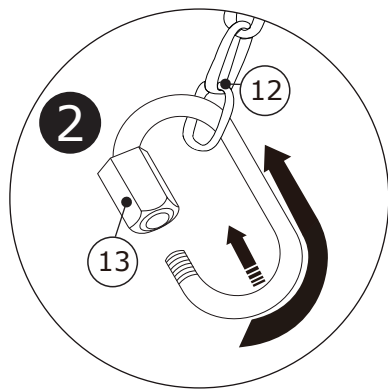
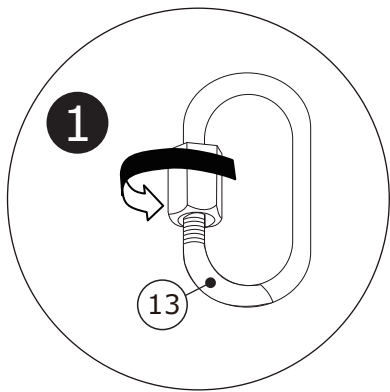
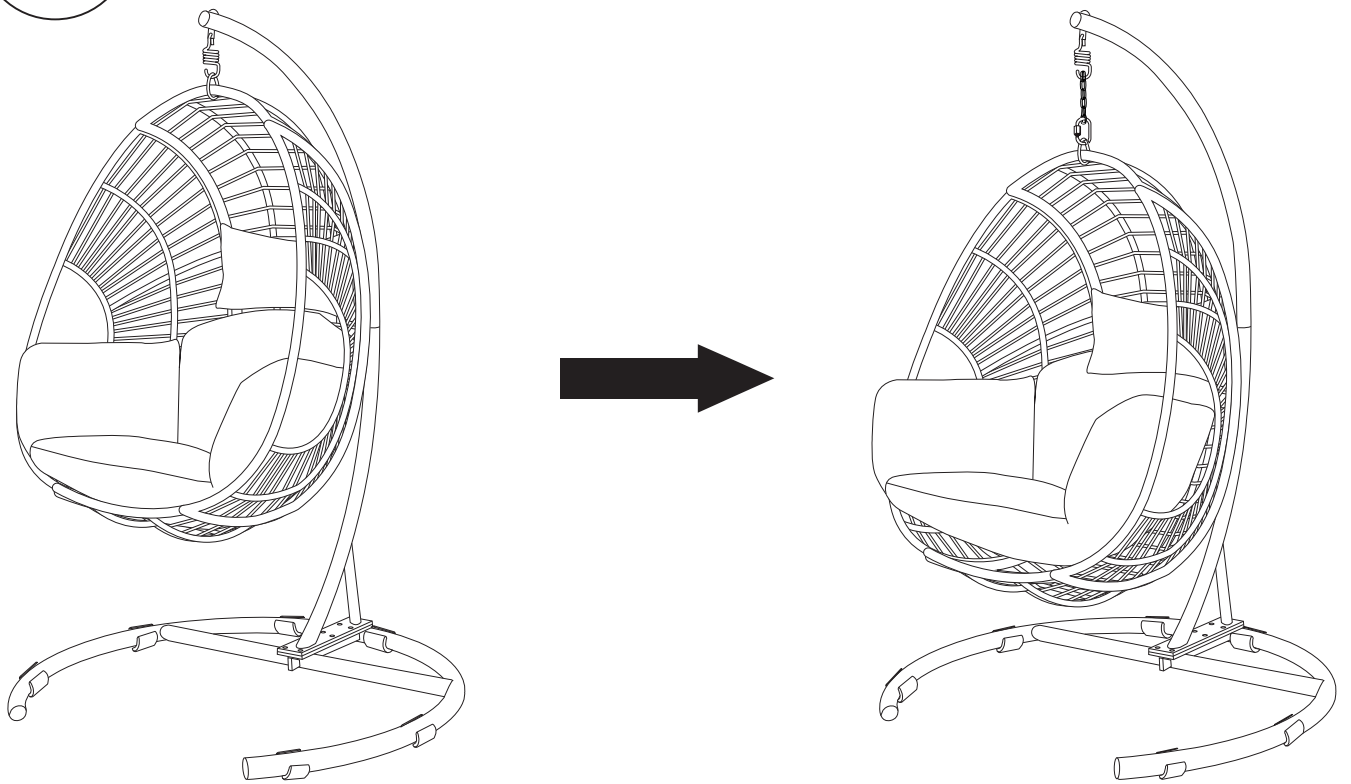

13

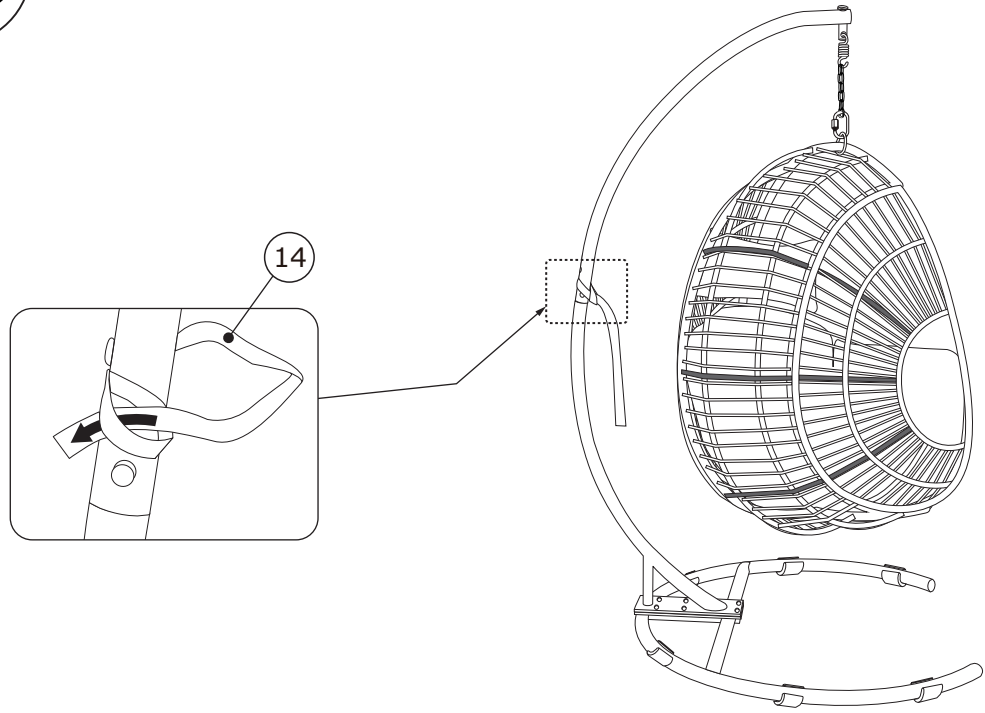

14

