

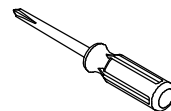

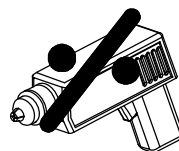

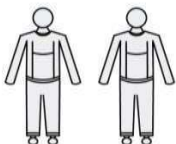

# Marte

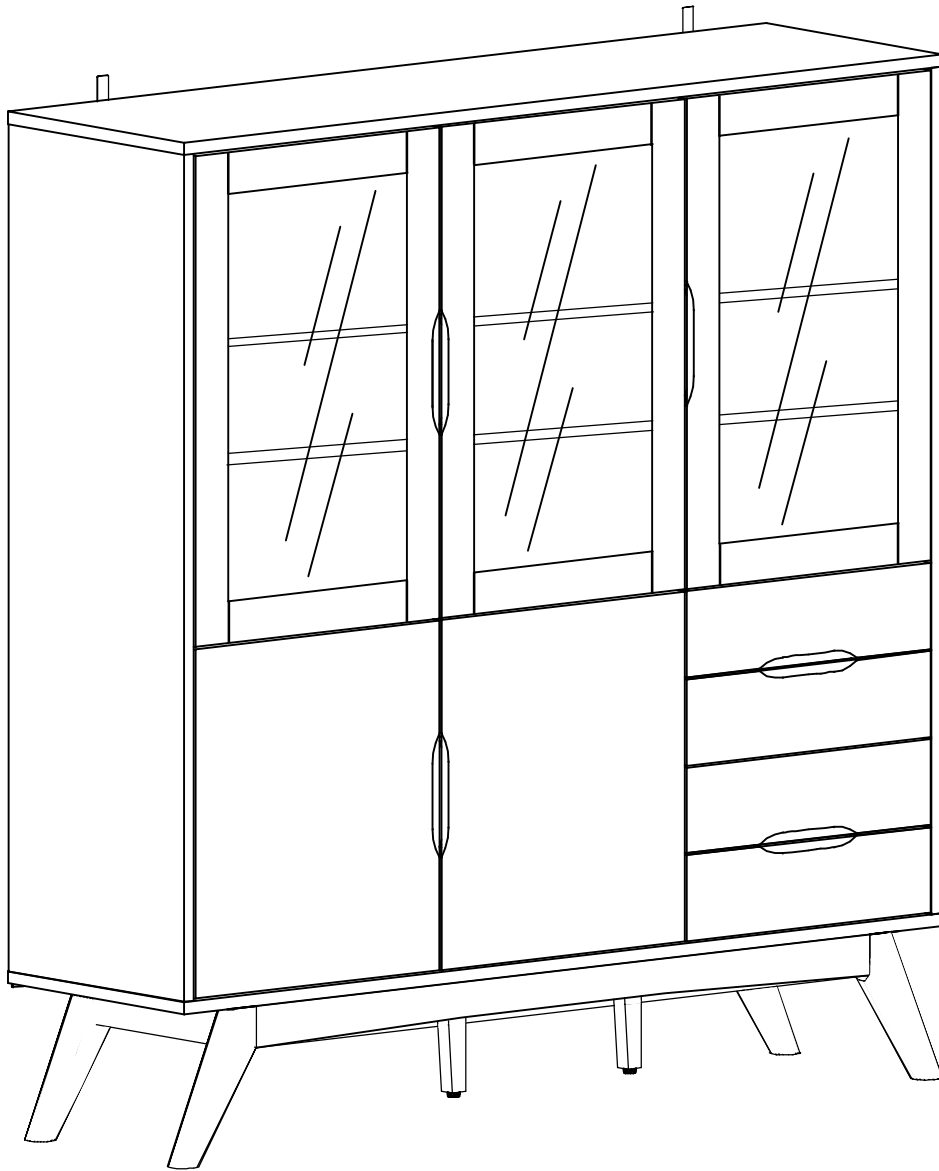
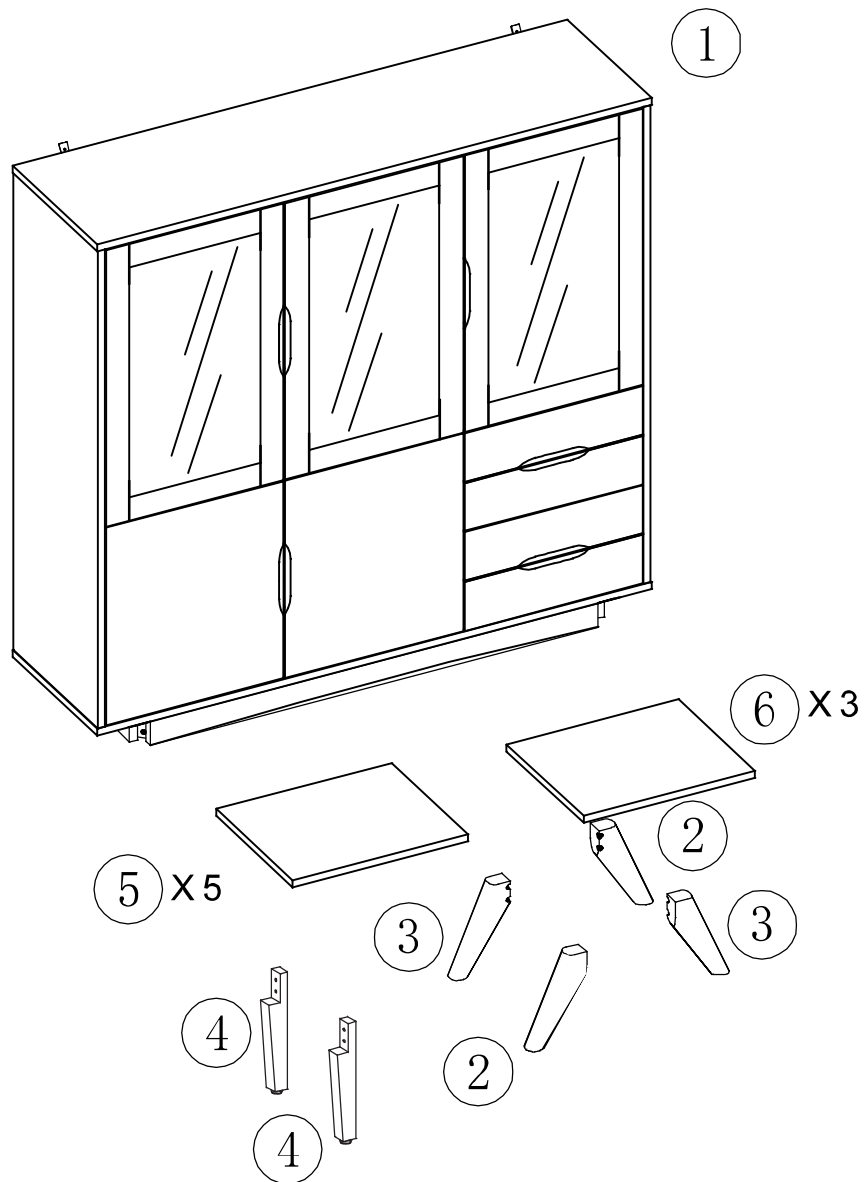
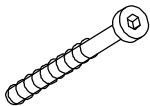

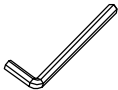

---



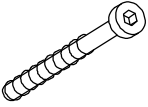

<p>8-A</p>  <p>M8 × 70mm</p>	<p>8-B</p>  <p>M8</p>	<p>8-C</p>  <p>M8</p>	<p>1-D</p>  <p>5mm</p>	<p>4-E</p>  <p>∅4 × 30mm</p>	<p>32-F</p> 
<p>2-G</p>  <p>M6</p>					

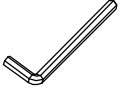
# MARTE

8-A  M8 × 70mm	8-B  M8	8-C  M8	1-D  5mm	4-E  - $\varnothing 4 \times 30$ mm
---	--	--	---	--

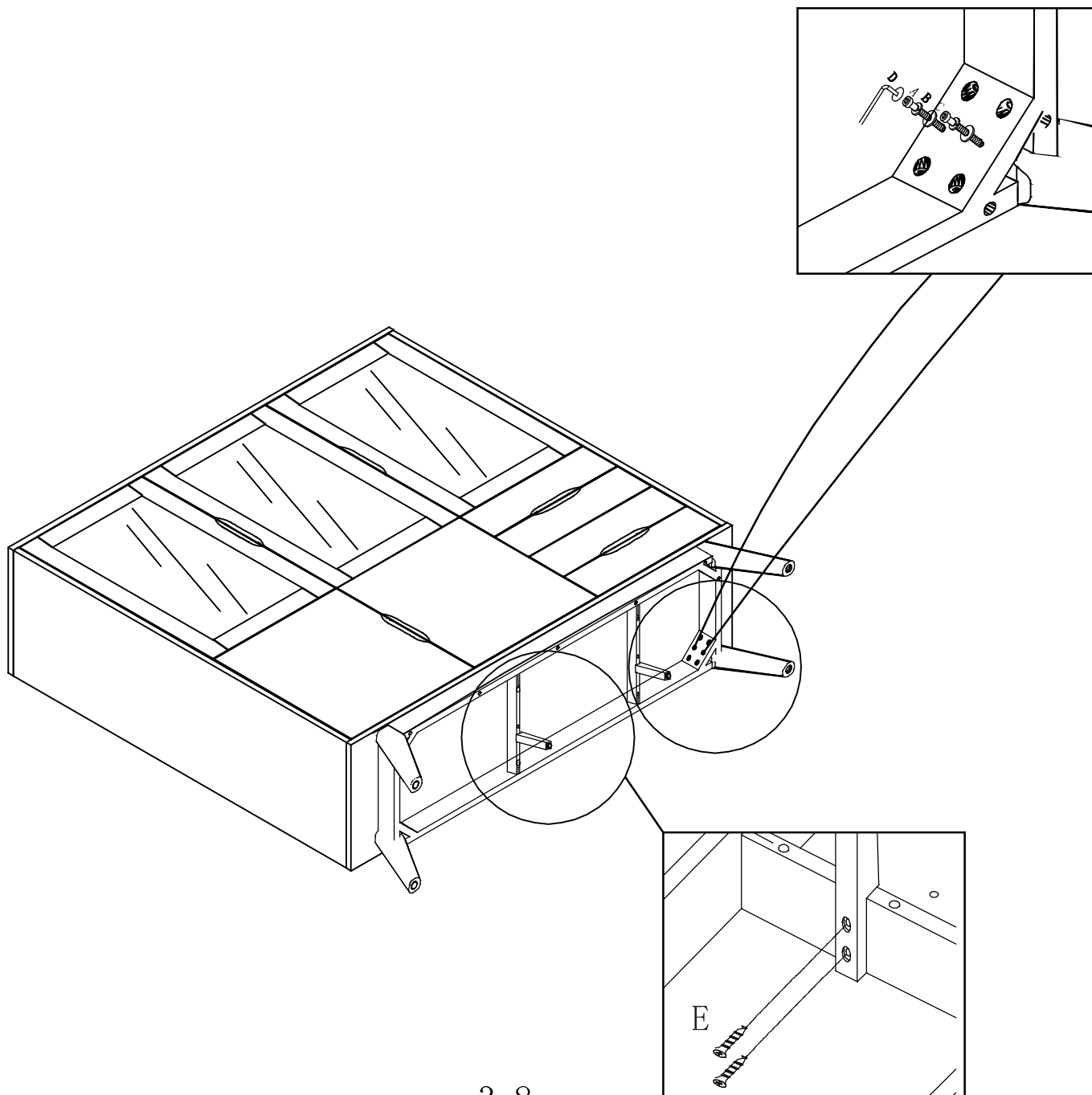

32-F

