

Ⓛ Aufbauanleitung

Ⓛ Notice de montage

Ⓛ Montagehandleiding

Ⓛ Montážní návod

Ⓛ Szerelési útmutató

Ⓛ Montaj talimatları

Ⓛ Assembly instruction

Ⓛ Istruzioni di montaggio

Ⓛ Instrukcja montażu

Ⓛ Navod na montaž

Ⓛ Instrucțiuni de montaj

Ⓛ Инструкция по монтажу

37-0001-32-09A

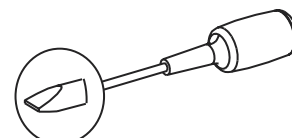
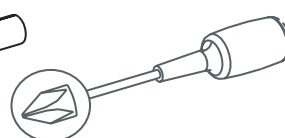
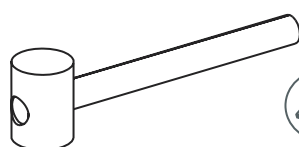
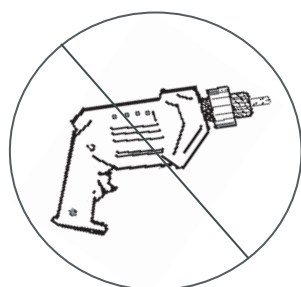
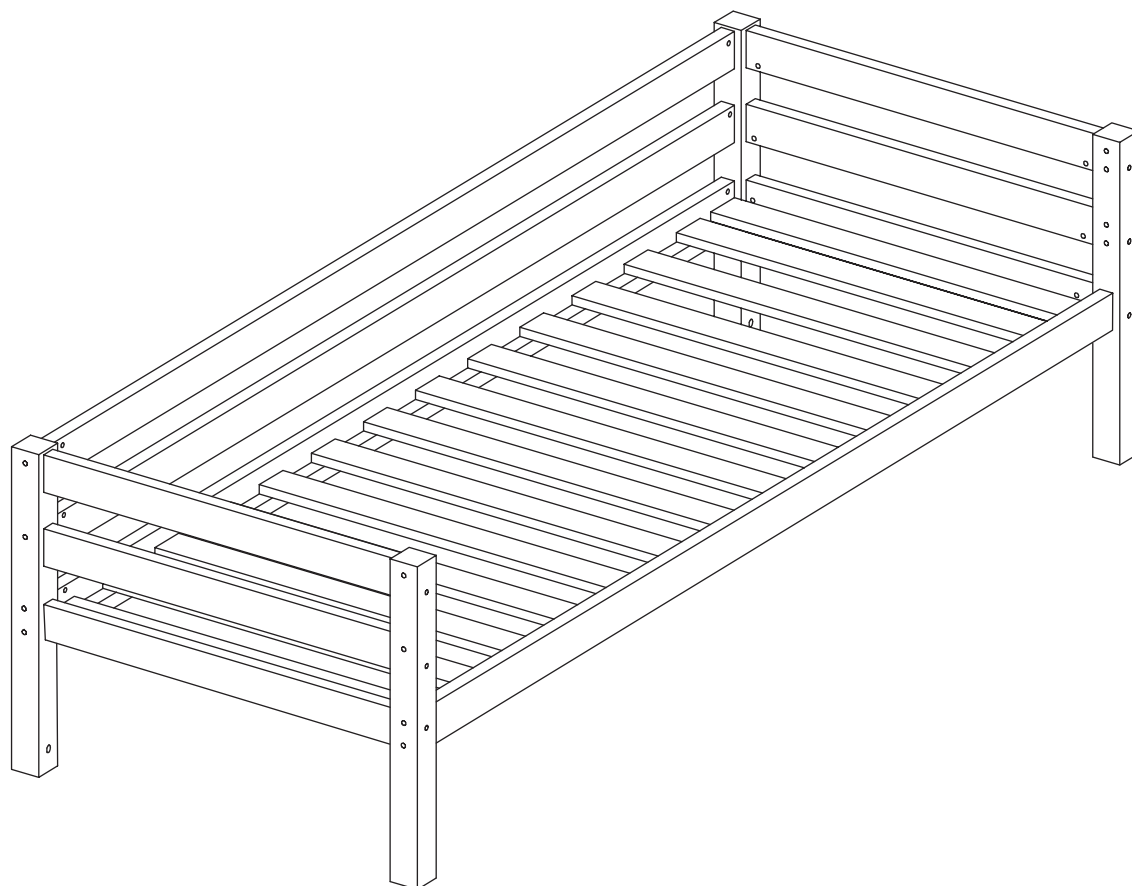

DIN EN 747-1+A1:2015
DIN EN 747-2+A1:2015

Service • Assistenza • Dienstverlening • Serwis Servis • Szerviz • Сервисная служба

Name • Nom • Nome • Naam • Nazwa • Jméno • Názov
Név • Denumire • Isim • Название

Nr. Nr. • No. • N° • Č • Sz • Номер

Typ • Тип • Type • Tip • Tipus • Druh • Тиро • Тип

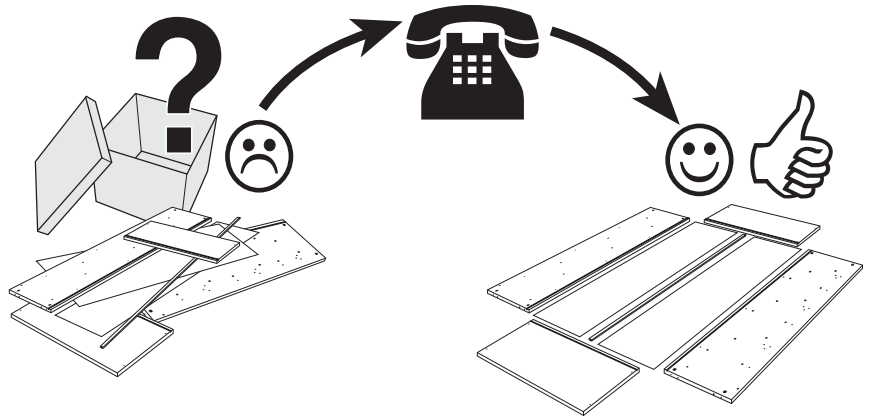
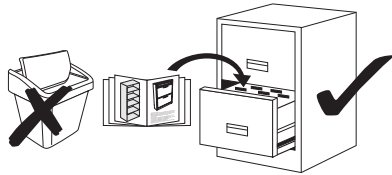

Detail specification

A.i. Nr.	Article Nr.	pcs
①	013001-32	x2
②	013002-32	x2
③	013003-32	x2
④	013004-32	x2
⑤	013005-32	x2
⑥	013006-32	x4
⑩	108820-00	x16

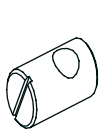
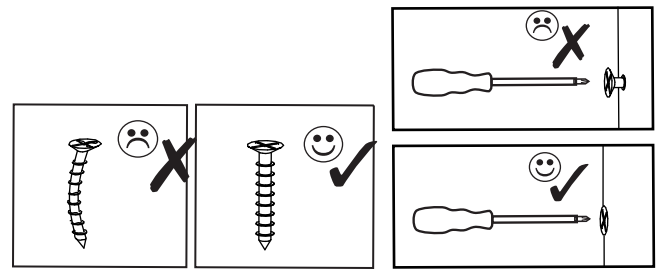
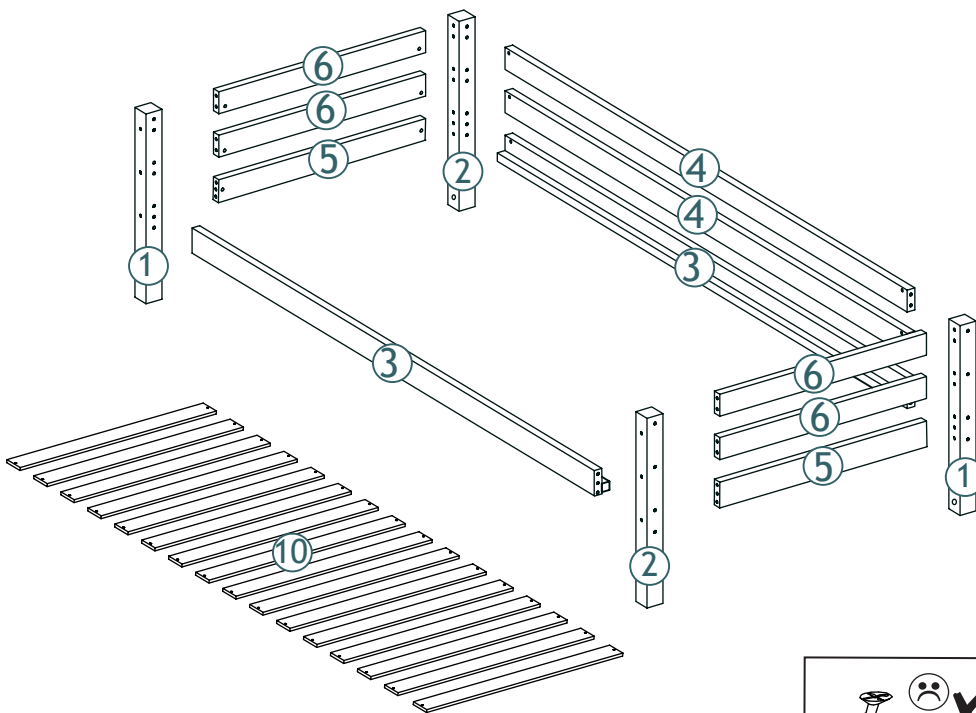

a

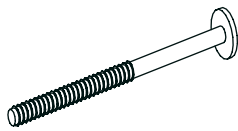

b

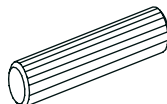

c

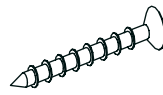

d



e

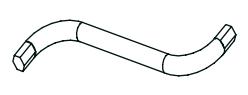

f

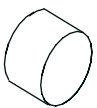

g

Fitting specification

A.i. Nr.	Article Nr.	Dimensions	pcs
a	1-000011-07	10x18	x24
b	1-000010-07	M6x100	x24
c	1-000013-00	8x40	x24
d	1-000012-07	3x30	x32
e	1-000014-57	6x8	x12
f	1-000015-07	Z4	x1
g	1-000016-57	16x10	x4

Make sure that there are no loose and leave screws!
Stellen Sie sicher, dass keine losen Schrauben und verlassen!
Zorg ervoor dat er geen losse en laat schroeven!
Assurez-vous qu'il n'y a pas lâches et laissent vis!

1-000001=

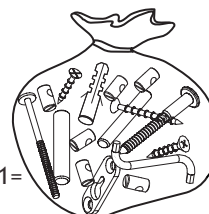

Ⓓ Aufbauanleitung

Ⓕ Notice de montage

Ⓖ Montagehandleiding

Ⓒ Montážní návod

Ⓗ Szerelési útmutató

Ⓓ Montaj talimatları

Ⓖ Assembly instruction

Ⓙ Istruzione di montaggio

Ⓟ Instrukcja montażu

Ⓒ Navod na montaž

Ⓡ Instrucțiuni de montaj

Ⓡ Инструкция по монтажу

37-0012-32-000

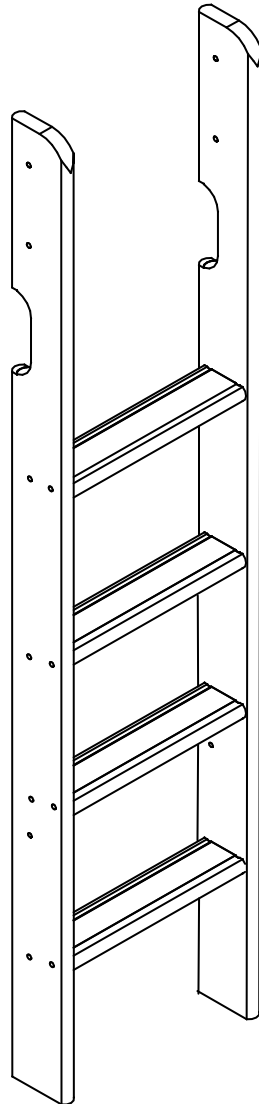

Product fulfill the standard "DIN EN 747-1:2015,DIN EN 747-2:2015"
Produktet opfylder krav til standard "DIN EN 747-1:2015,DIN EN 747-2:2015"
Produkt entspricht der Norm "DIN EN 747-1:2015,DIN EN 747-2:2015"
Produit conforme au standard "DIN EN 747-1:2015,DIN EN 747-2:2015"

IMPORTANT-READ CAREFULLY AND RETAIN
WICHTIG-SORGFÄLTIG LESEN UND AUFBEWAHREN
VIGTIGT-LÆS grundigt igennem og opbevar
IMPORTANT-LIRE ATTENTIVEMENT ET A CONSERVER

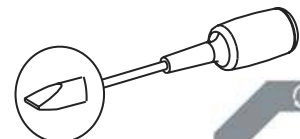
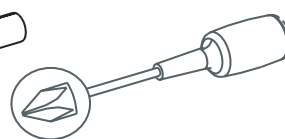
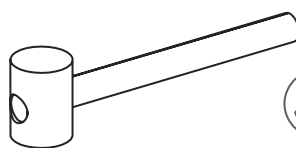
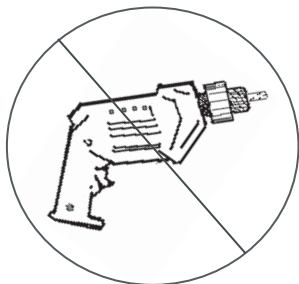

DIN EN 747-1+A1:2015
DIN EN 747-2+A1:2015



Service • Assistenza • Dienstverlening • Serwis Servis • Szerviz • Сервисная служба

Name • Nom • Nome • Naam • Nazwa • Jméno • Názov
Név • Denumire • Isim • Название

Nr. Nr. • No. • N° • Č • Sz • Номер

Typ • Тип • Type • Tip • Tipus • Druh • Тиро • Тип

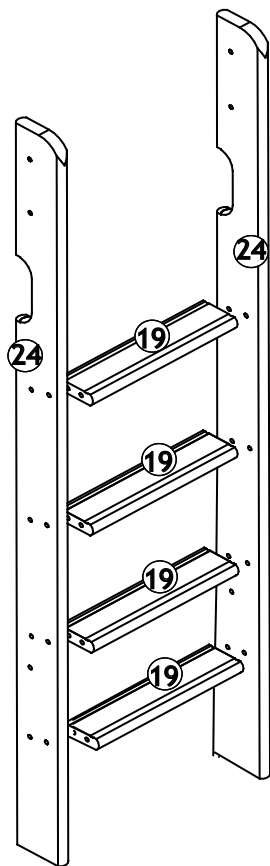
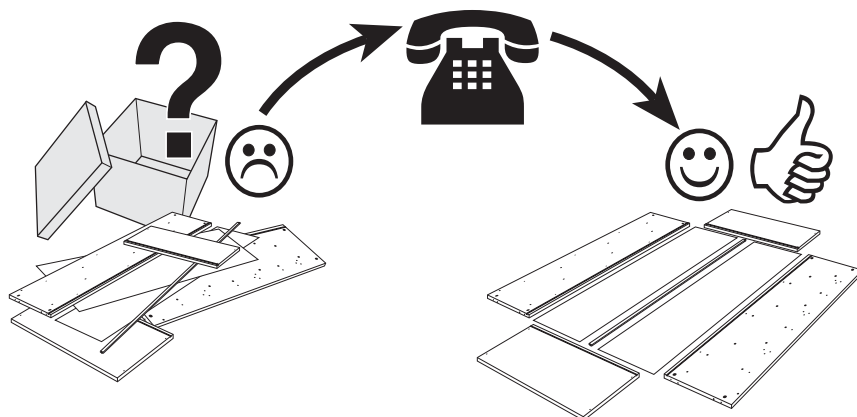
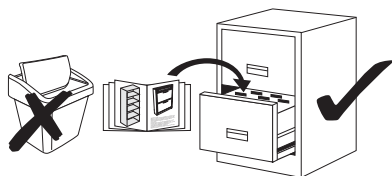

Detail specification

A.i. Nr.	Article Nr.	pcs
24	013023-32	x2
19	013018-32	x4

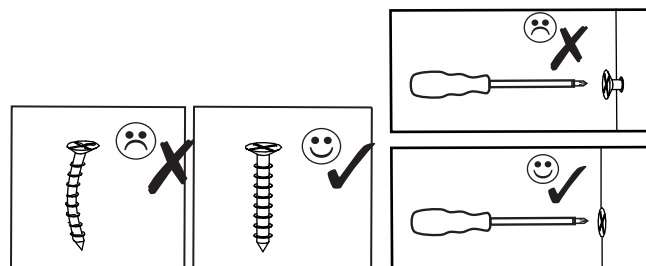

Fitting specification

A.i. Nr.	Article Nr.	Dimensions	pcs
o	1-000025-07	M6x80	x2
p	1-000026-07	M6x120	x2
t	1-000027-07	8x15	x2
e	1-000014-57	8x13	x4
r	1-000028-07	7x60	x16
s	1-000029-07	4x50	x3

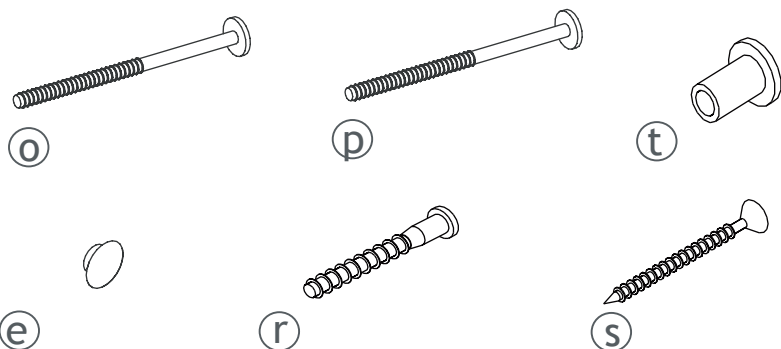

1-000001=

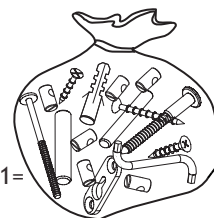

1.

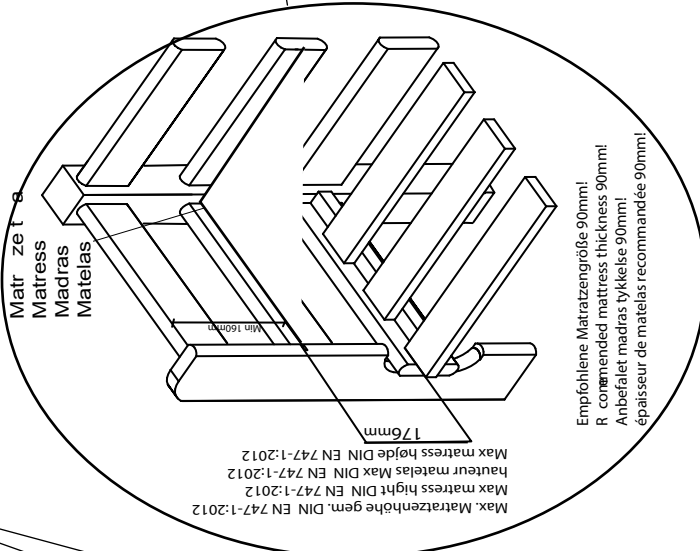
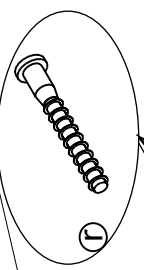
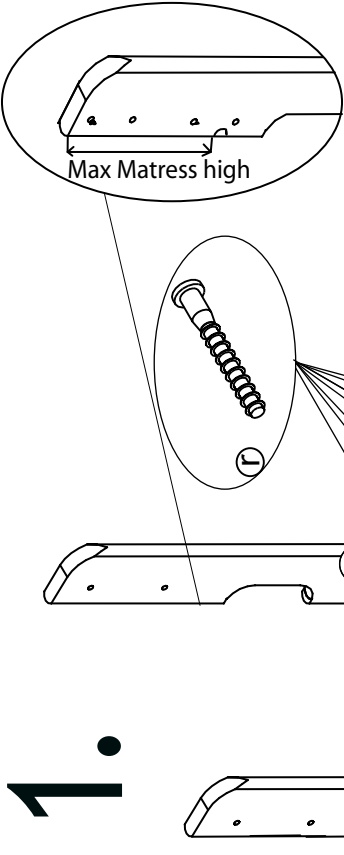

Mattress
Matras
Madrass
Madrass

2.

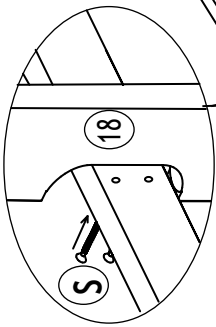
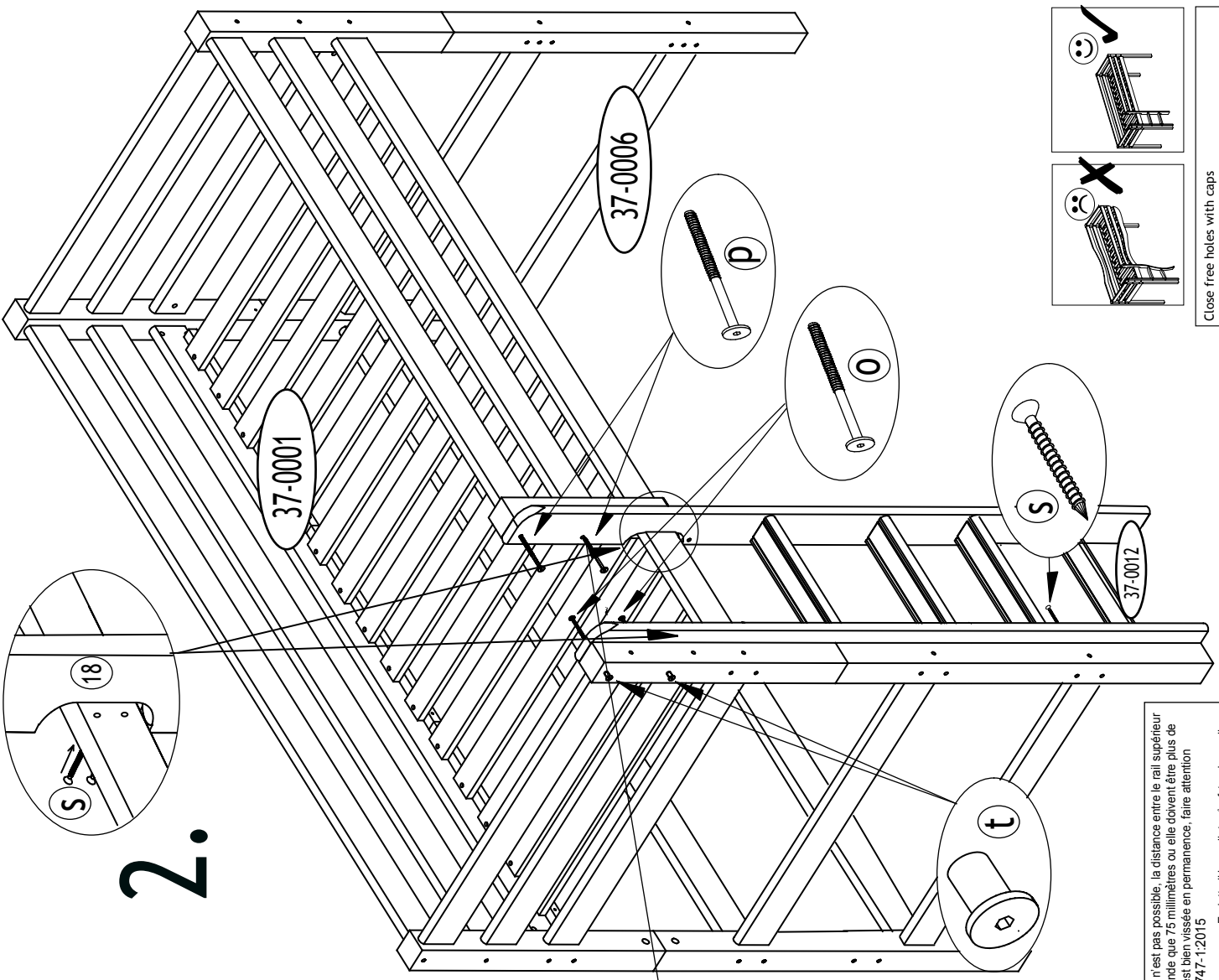

37-0001

37-0006

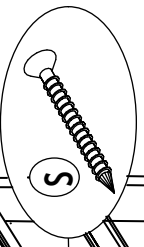
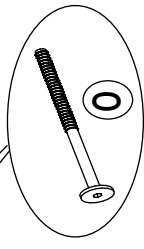
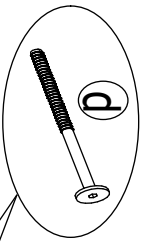

37-0012

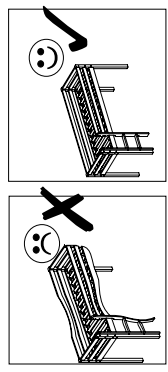
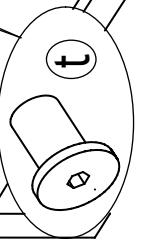

Close free holes with caps
Luk alle huller med propper
Schliessen Sie die offenen Löcher mit den Deckklappen
Fermez les trous découverts avec les chapes



VORSICHT-dass sich Kinder mit Gegenständen, z. B. Stricken, Schnüren, Kordeln, Gurten, Bändern, die an einem Etagenbett/Hochbett befestigt oder abhängig sind, strangulieren können
Important - that children with objects such as ropes, cords, straps, bands, beginning at bed / loft mounted or are dependent, strangulation

DE Halten Sie das Bett stets in Kontakt mit der Wand. Falls das nicht möglich ist, darf der Abstand zwischen der oberen Abstützung und der Wand nicht mehr als 75 mm betragen oder der Abstand muß größer als 230 mm sein. Alle Schrauben und Befestigungen müssen immer fest sein. Stellen Sie sicher, dass es keine lose Schrauben gibt. DIN EN 747-1:2015
UK Please hold the bed straight in contact with the wall. If that is not possible, the distance between the upper safety rail and the wall may not be larger than 75 mm or it must be more than 230mm. All Screws and fittings must always be tight. Ensure that there are not loose screws. DIN EN 747-1:2015

FR Tenez le lit droit contact avec le mur. Si ce n'est pas possible, la distance entre le rail supérieur de soutien et le mur ne peut ne pas être plus grande que 75 millimètres ou elle doit être plus de 230 millimètres. Vérifier que la quincaillerie est bien vissée en permanence, faire attention à des vis qui peuvent se dévisser. DIN EN 747-1:2015
DK Hold venligt sengen i lige kontakt med væggen. Er dette ikke muligt må afstanden mellem øverste sengehest og væg ikke være mere end 75mm eller skal den være mere end 230mm. Alle skruer og beslag skal altid være strammet til. Vær opmærksom på, at der ikke er løse skruer. DIN EN 747-1:2015

Ⓛ Aufbauanleitung

Ⓛ Notice de montage

Ⓛ Montagehandleiding

Ⓛ Montážní návod

Ⓛ Szerelési útmutató

Ⓛ Montaj talimatları

Ⓛ Assembly instruction

Ⓛ Istruzione di montaggio

Ⓛ Instrukcja montażu

Ⓛ Navod na montaž

Ⓛ Instrucțiuni de montaj

Ⓛ Инструкция по монтажу

37-0021-32-09A

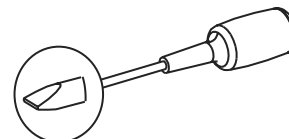
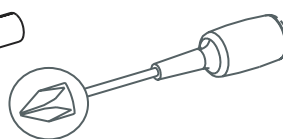
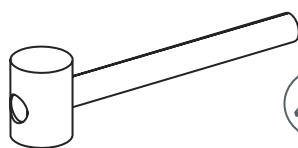
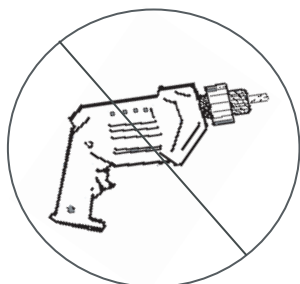
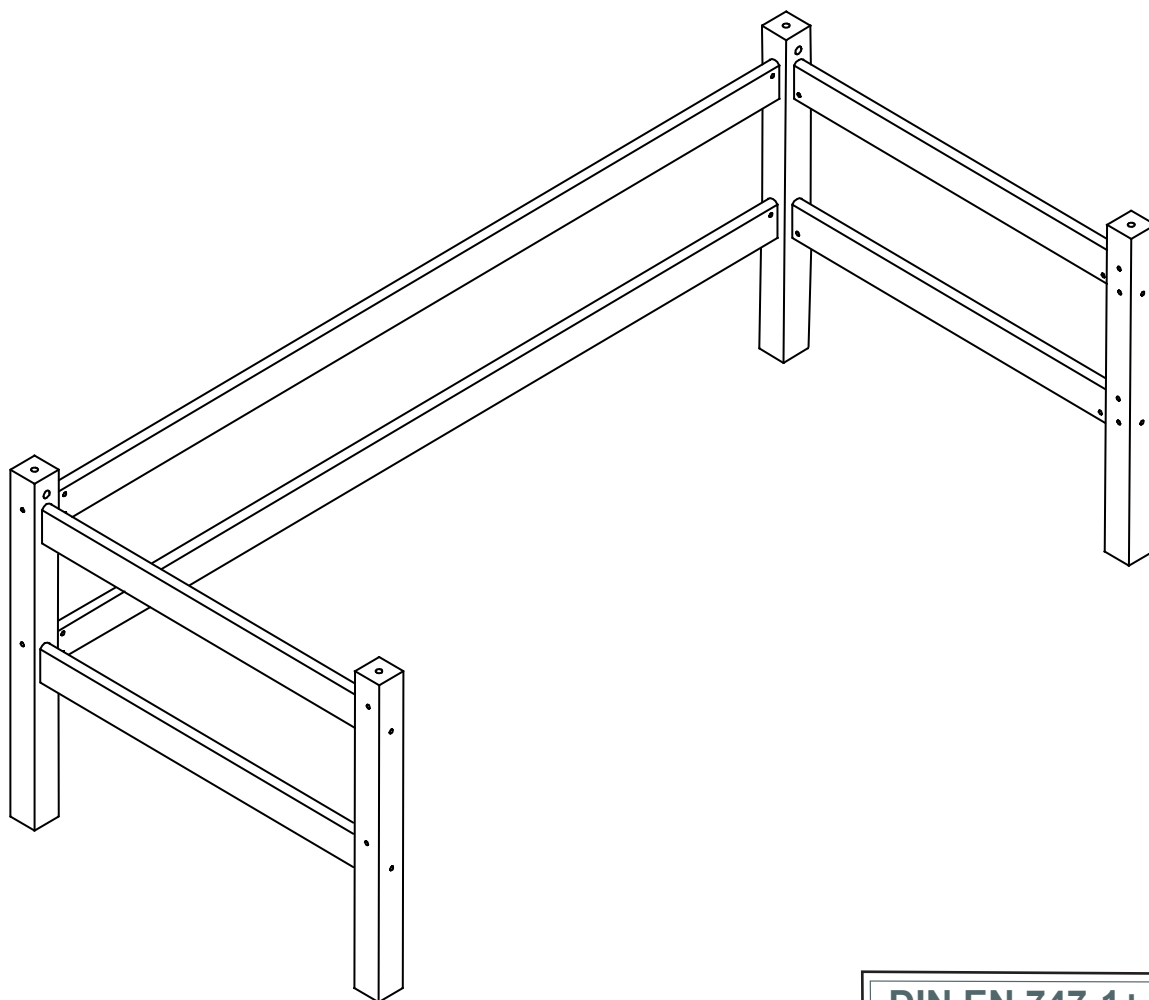

DIN EN 747-1+A1:2015
DIN EN 747-2+A1:2015

Product fulfill the standard "DIN EN 747-1:2015,DIN EN 747-2:2015"
Produktet opfylder krav til standard "DIN EN 747-1:2015,DIN EN 747-2:2015"
Produkt entspricht der Norm "DIN EN 747-1:2015,DIN EN 747-2:2015"
Produit conforme au standard "DIN EN 747-1:2015,DIN EN 747-2:2015"



IMPORTANT-READ CAREFULLY AND RETAIN
WICHTIG-SORGFÄLTIG LESEN UND AUFBEWAHREN
VIGTIGT-LÆS grundigt igennem og opbevar
IMPORTANT-LIRE ATTENTIVEMENT ET A CONSERVER

Service • Assistenza • Dienstverlening • Serwis Servis • Szerviz • Сервисная служба

Name • Nom • Nome • Naam • Nazwa • Jméno • Názov
Név • Denumire • Isim • Название

Nr. Nr. • No. • N° • Č • Sz • Номер

Typ • Тип • Type • Tip • Tipus • Druh • Тиро • Тип

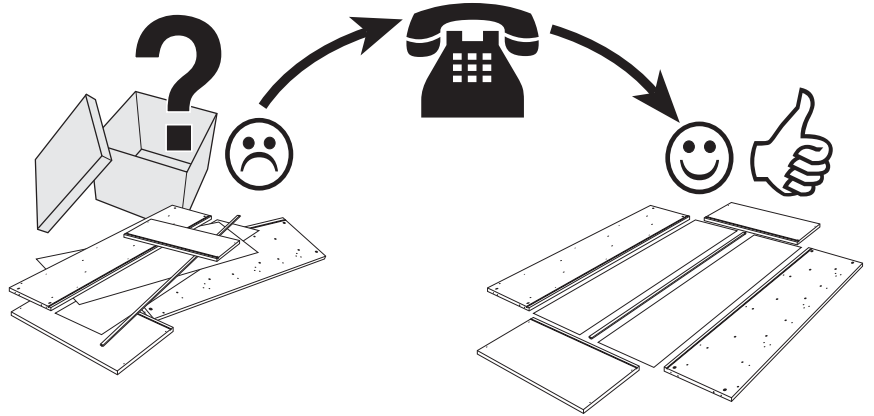
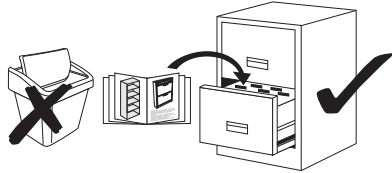

Detail specification

A.i. Nr.	Article Nr.	pcs
4	013004-32	x2
6	013006-32	x4
56	013060-32	x2
57	013061-32	x2

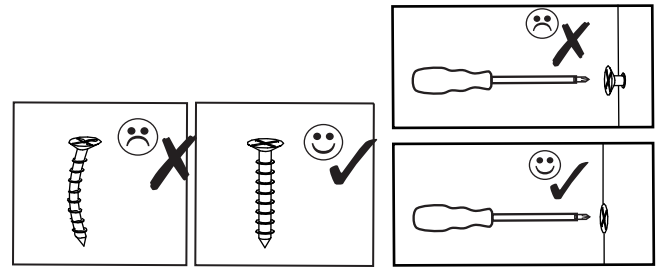
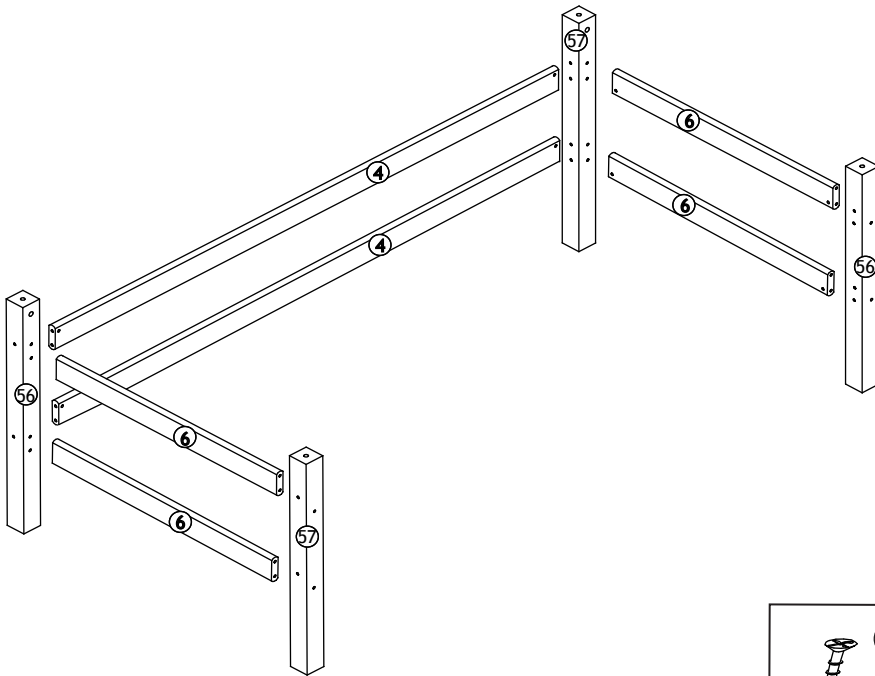

Fitting specification

A.i. Nr.	Article Nr.	Dimensions	pcs
a	1-000011-07	M6x10/6	x12
b	1-000010-07	M6x100	x12
c	1-000013-00	8x40	x12
e	1-000014-57	6x8	x20
f	1-000015-07	Z4	x1
l	1-000021-07	M10x15/28	x4
m	1-000022-07	M10x15/28	x4
n	1-000023-07	M10x115	x4
k	1-000024-07	D16	x4
g	1-000016-57	16x10	x4

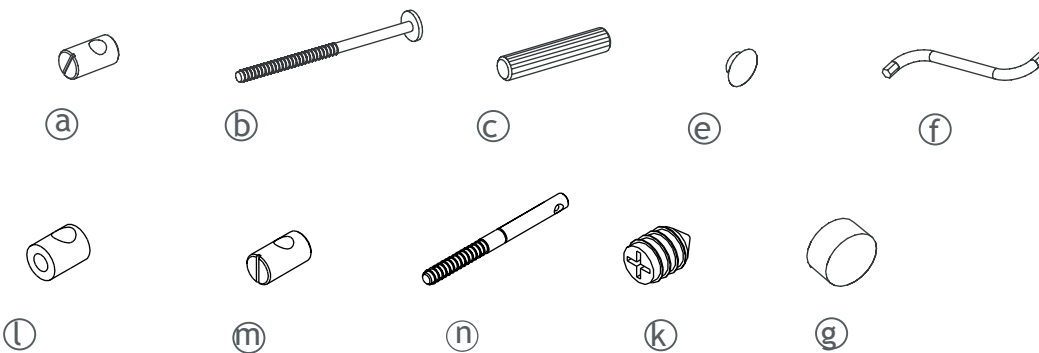

1-000001=

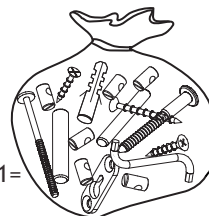

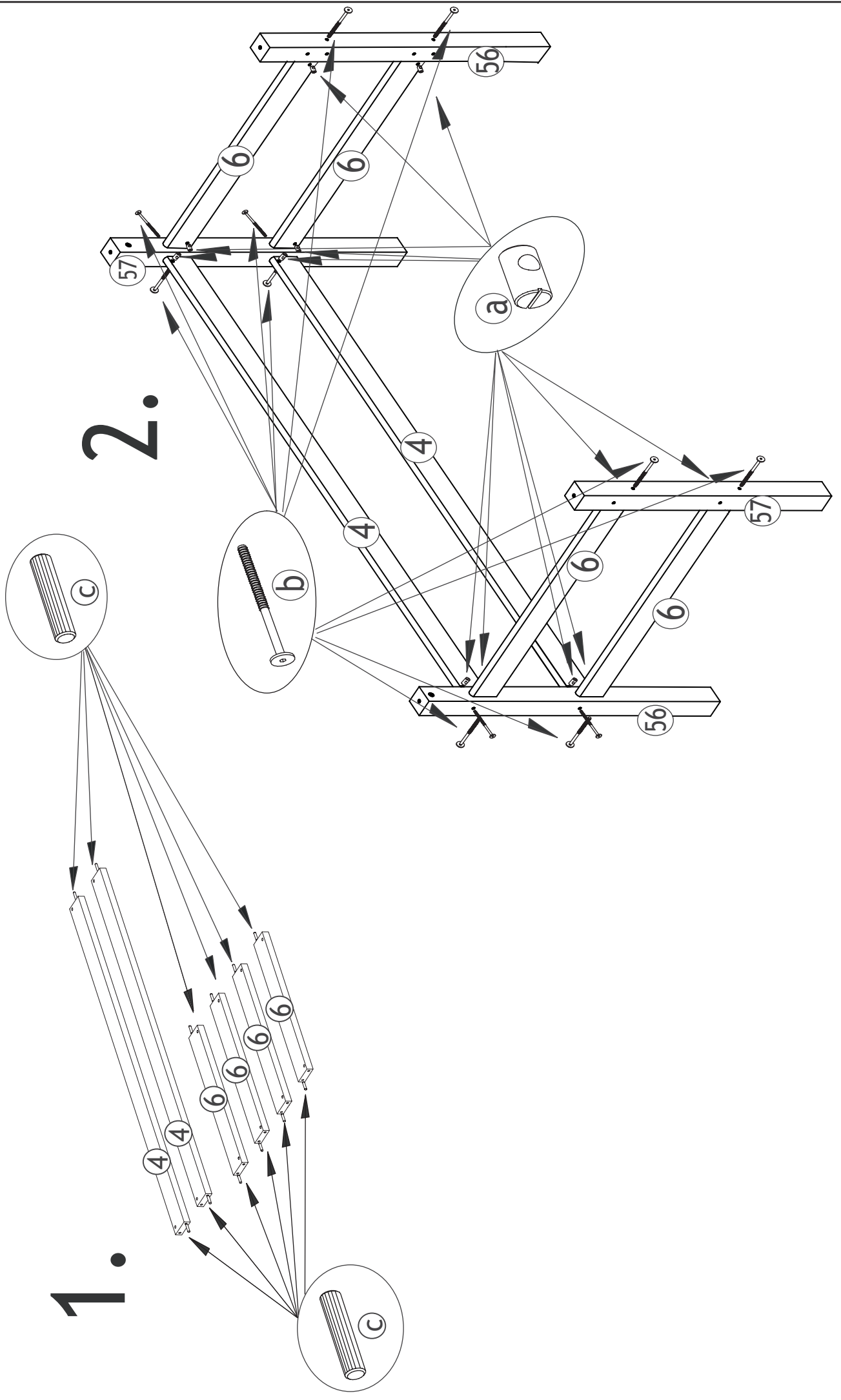

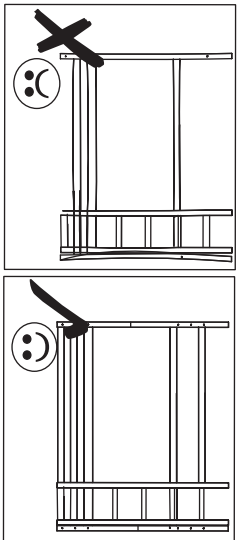
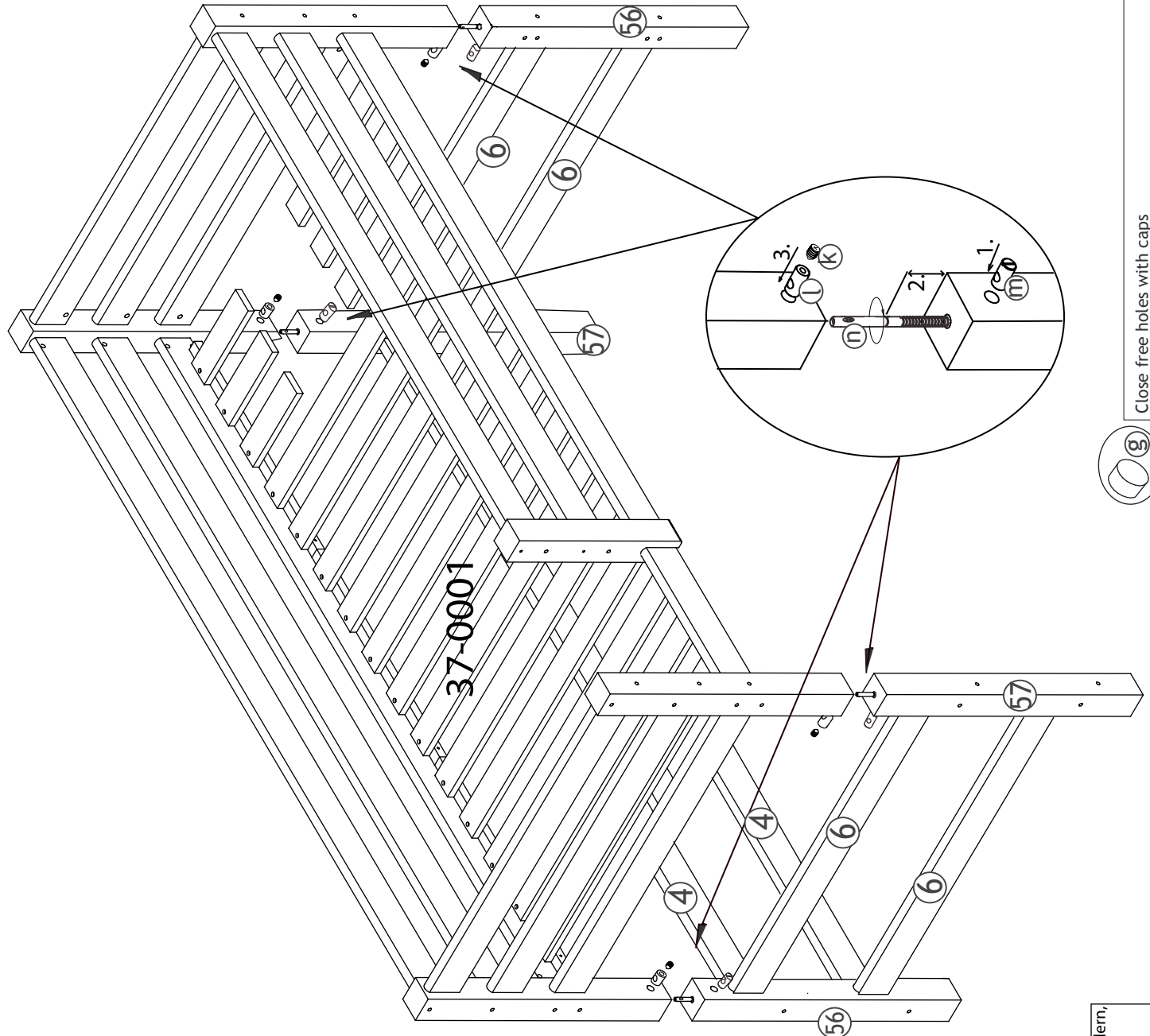

- (DE)** Halten Sie das Bett stets in Kontakt mit der Wand. Falls das nicht möglich ist, darf der Abstand zwischen der oberen Absturzsicherung und der Wand nicht mehr als 75 mm betragen oder der Abstand muß größer als 230 mm sein. Alle Schrauben und Befestigungen müssen immer fest sein. Stellen Sie sicher, dass es keine lose Schrauben gibt. DIN EN 747-1:2015
- (UK)** Please hold the bed straight in contact with the wall. If that is not possible, the distance between the upper safety rail and the wall may not be larger than 75 mm or it must be more than 230 mm. All Screws and fittings must always be tight. Ensure that there are not loose screws. DIN EN 747-1:2015
- (FR)** Tenez le lit droit contre le mur. Si ce n'est pas possible, la distance entre le rail supérieur de sécurité et le mur ne peut pas être plus grande que 75 millimètres ou elle doit être plus de 230 millimètres. Vérifier que la quincaillerie est bien vissée en permanence, faire attention à des vis qui peuvent se dévisser. DIN EN 747-1:2015
- (DK)** Hold venligt sengen i lige kontakt med væggen. Er dette ikke muligt må afstanden mellem øverste sengehest og væg ikke være mere end 75mm eller skal den være mere end 230mm. Alle skruer og beslag skal altid være strammet til. Vær opmærksom på, at der ikke er løse skruer. DIN EN 747-1:2015

VORSICHT-dass sich Kinder mit Gegenständen, z. B. Stricken, Schnüren, Kordeln, Gurten, Bändern, die an einem Etagenbett/Hochbett befestigt oder abhängig sind, strangulieren können

Important - that children with objects such as ropes, cords, straps, bands, beginning at bunk bed / loft mounted or are dependent, strangulation

Close free holes with caps
 Luk alle huller med propper
 Schliessen Sie die offenen Löcher mit den Deckkappen
 Fermez les trous découverts avec les chapes

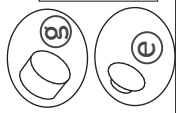

Ⓛ Aufbauanleitung

Ⓛ Notice de montage

Ⓛ Montagehandleiding

Ⓛ Montážní návod

Ⓛ Szerelési útmutató

Ⓛ Montaj talimatları

Ⓛ Assembly instruction

Ⓛ Istruzione di montaggio

Ⓛ Instrukcja montażu

Ⓛ Navod na montaž

Ⓛ Instrucțiuni de montaj

Ⓛ Инструкция по монтажу

37-0002-32-200

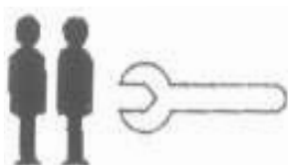
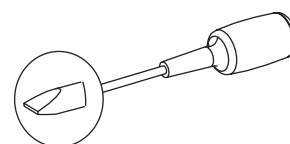
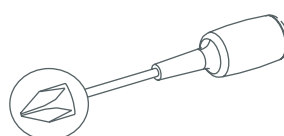
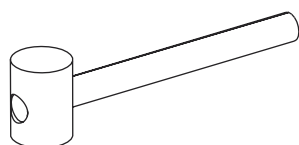
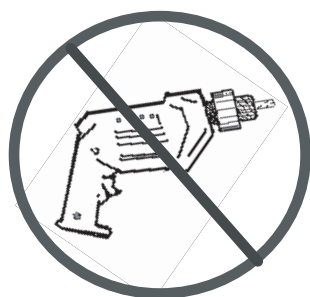
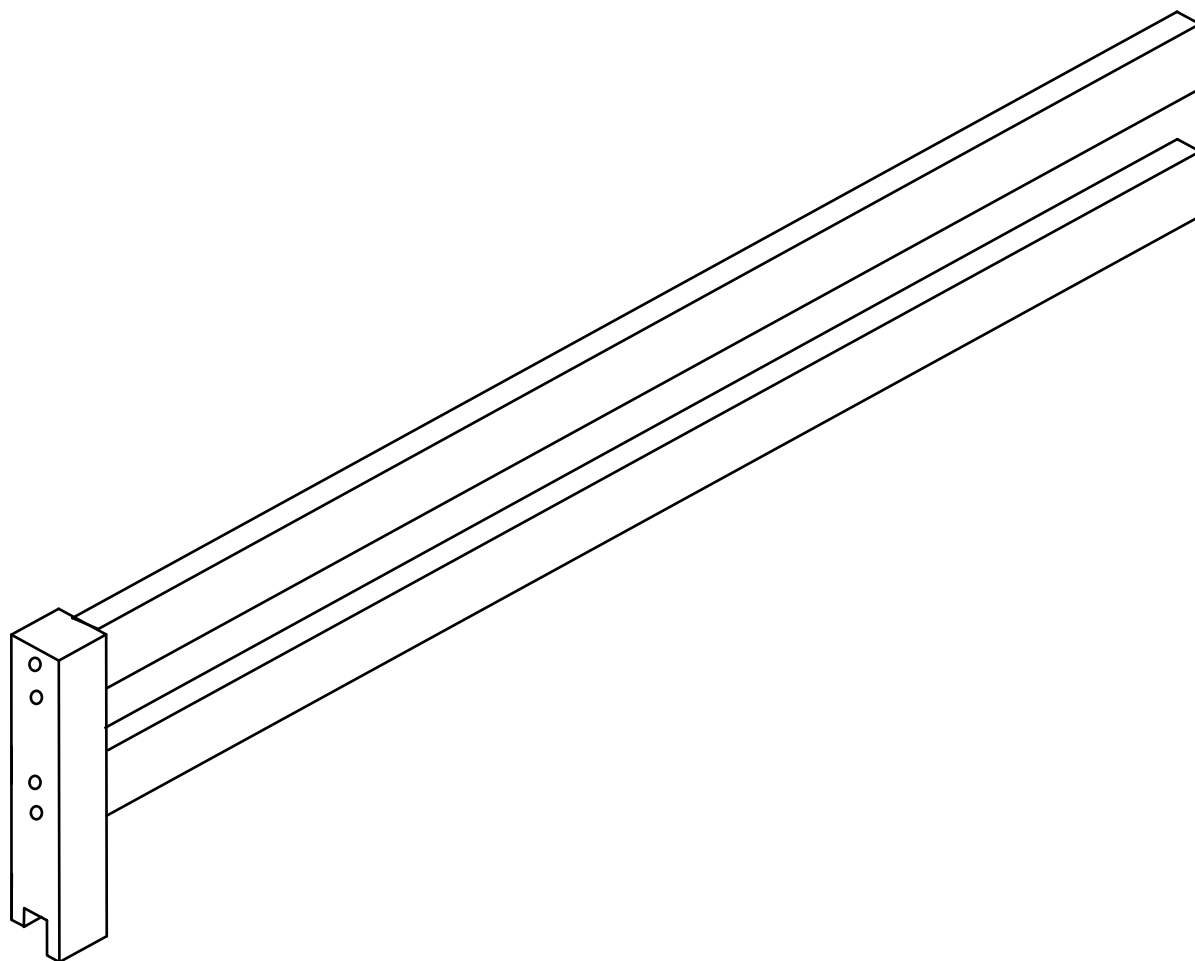

DIN EN 747-1+A1:2015
DIN EN 747-2+A1:2015



Service • Assistenza • Dienstverlening • Serwis Servis • Szerviz • Сервисная служба

Name • Nom • Nome • Naam • Nazwa • Jméno • Názov
Név • Denumire • Isim • Название

Nr. • No. • N° • Č • Sz • Номер

Typ • Type • Tip • Tipus • Druh • Тип • Тип

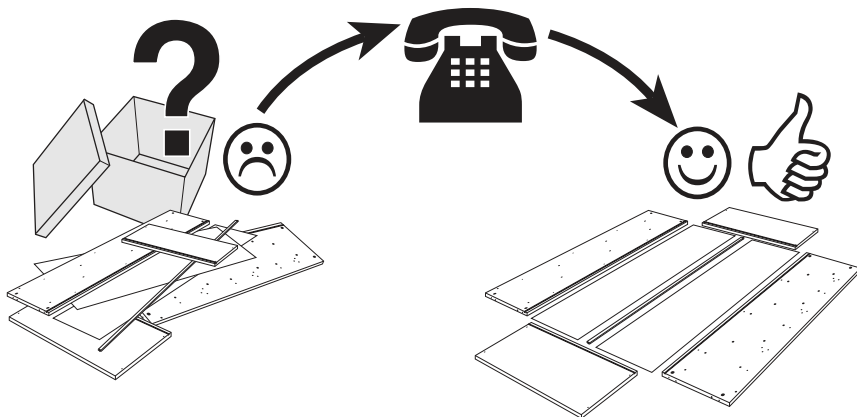
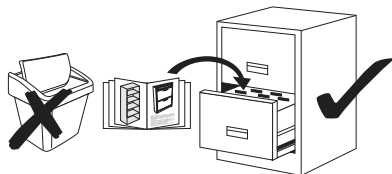

Detail specification

A.i. Nr.	Article Nr.	pcs
7	013007-32	x1
8	013008-32	x2

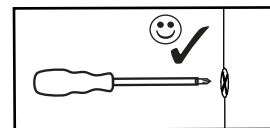
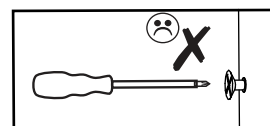
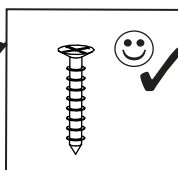
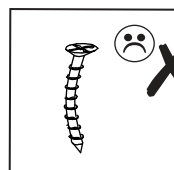
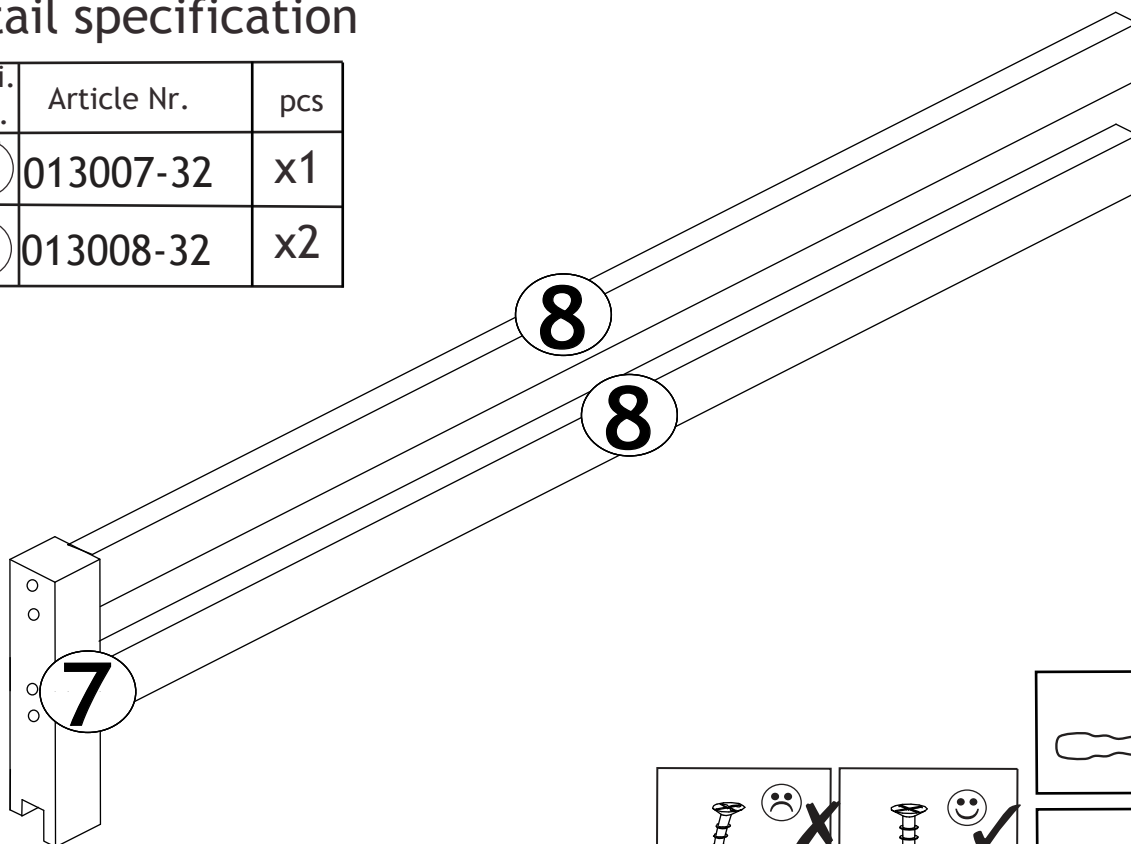

h



i

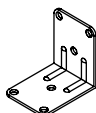

j



c

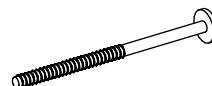

b



a



e



g

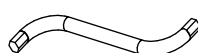

f

Fitting specification

A.i. Nr.	Article Nr.	Dimensions	pcs
h	1-000020-07	3,5x25	x3
i	1-000019-07	3,5x15	x4
j	1-000018-07	48x40x2,5	x1
c	1-000013-00	8x40	x4
b	1-000010-07	M6x100	x4
a	1-000011-07	M6x10/6	x4
e	1-000014-57	6x8	x2
g	1-000017-07	45x45x2	x1
f	1-000015-07	Z4	x1

1-000001=

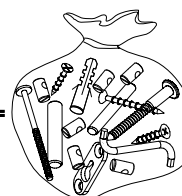

37-0001+37-0002

1.

2.

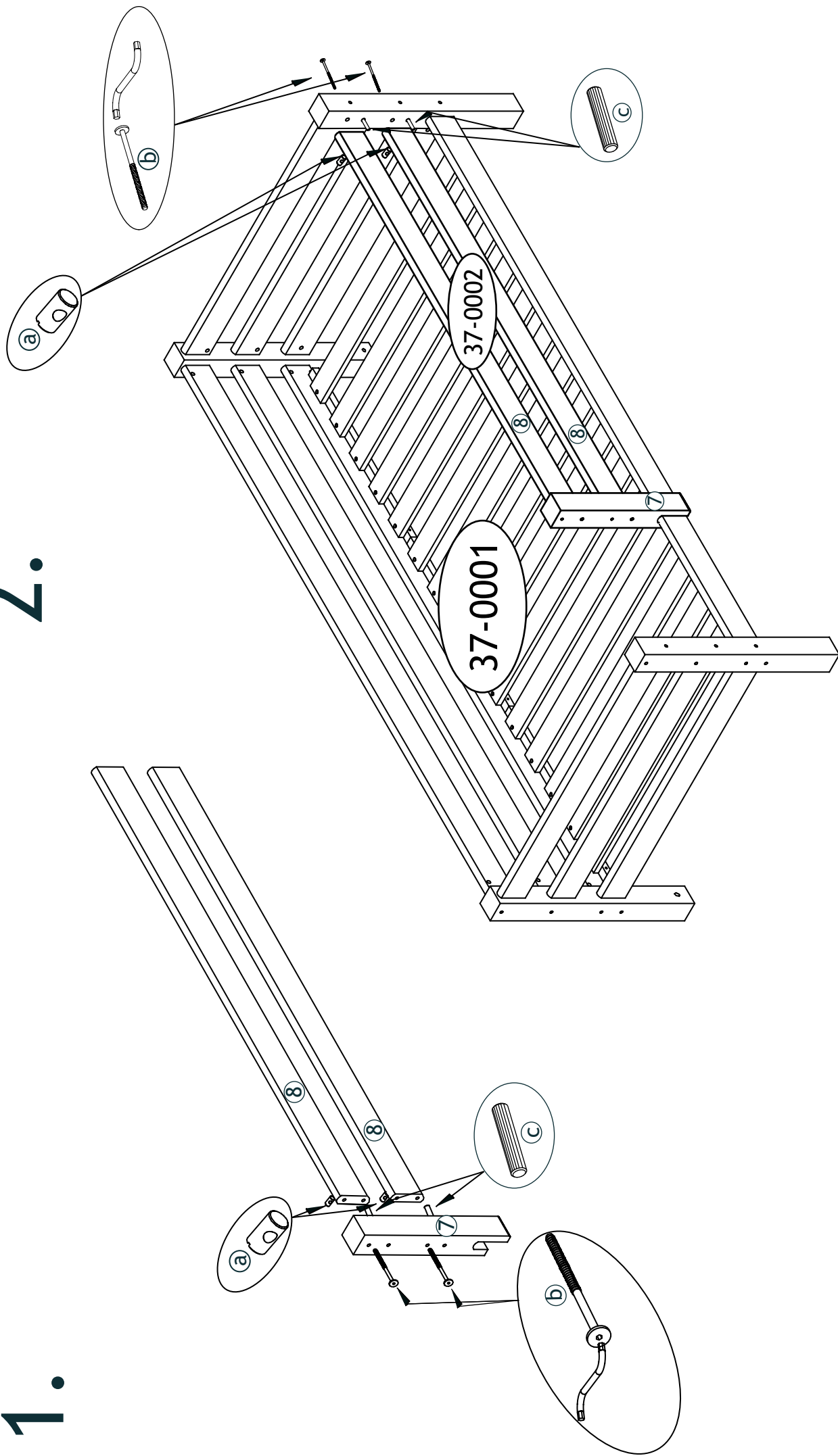

3.

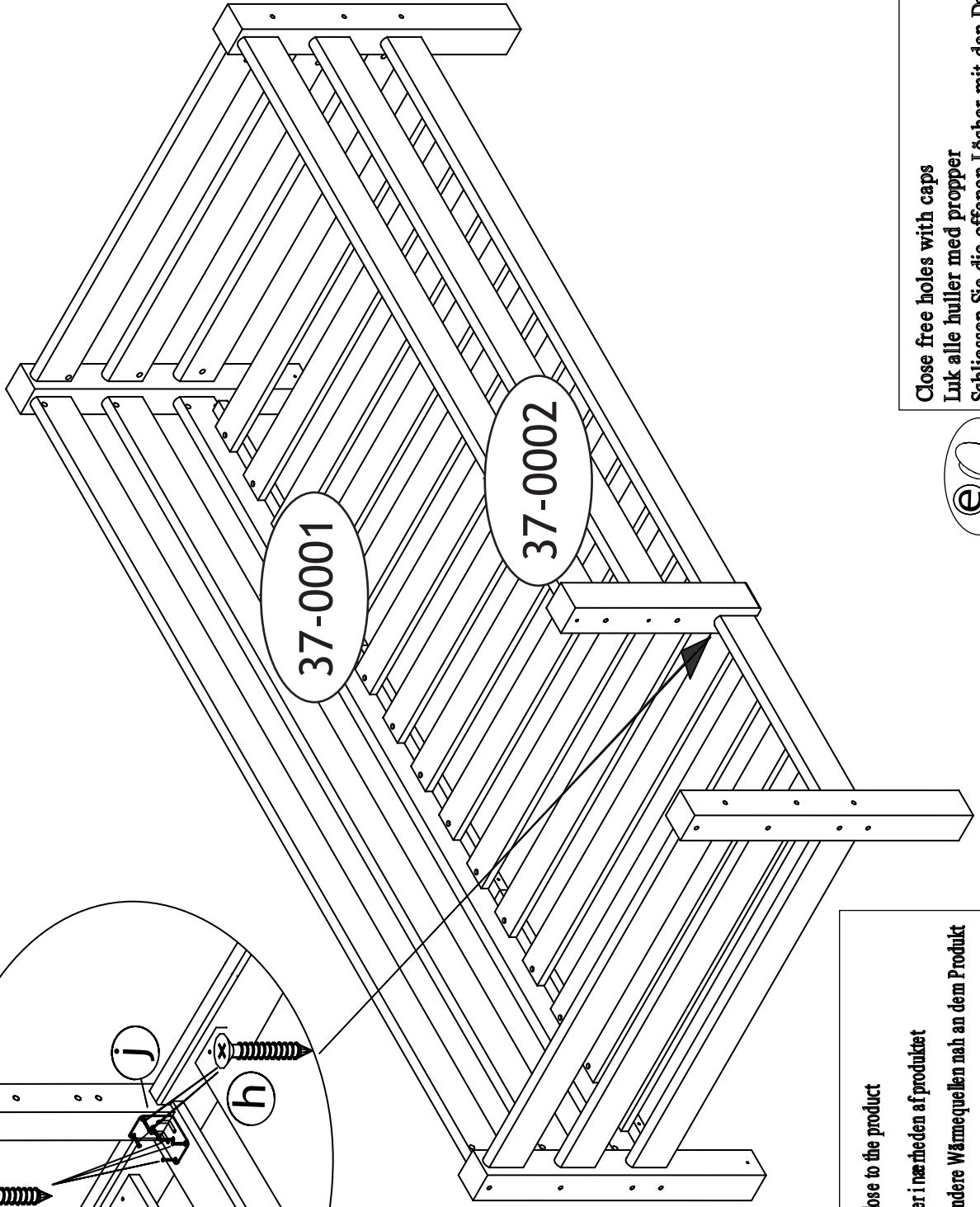
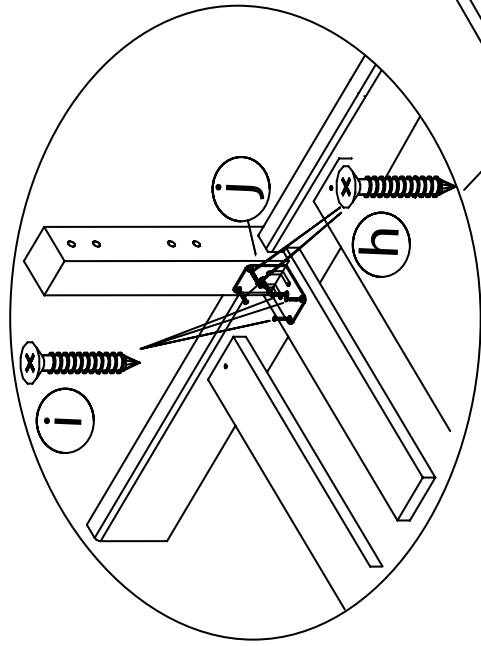

- (UK)** Be aware of the risk of open fire and other heating sources close to the product
- (DK)** Vær opmærksom på risikoen for åben ild og andre varmekilder i nærheden af produktet
- (DE)** Berücksichtigen Sie die Gefahr des geöffneten Feuers und andere Wärmequellen nah an dem Produkt
- (FR)** Ne pas placer le produit à proximité du feu ou du chauffage puissant

Close free holes with caps
Luk alle huller med propper
Schliessen Sie die offenen Löcher mit den Deckkappen
Fermez les trous découverts avec les chapes



37-0017+37-0002

1.

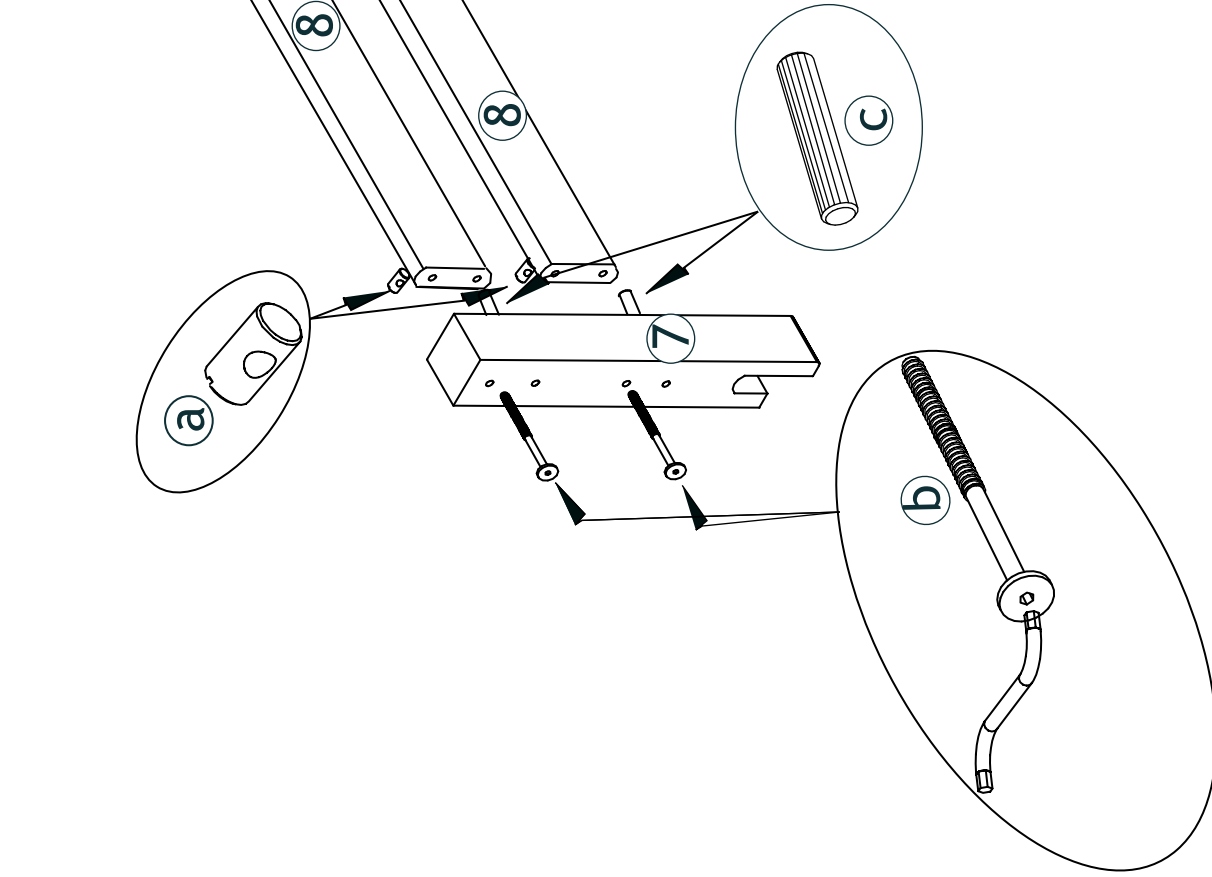

2.

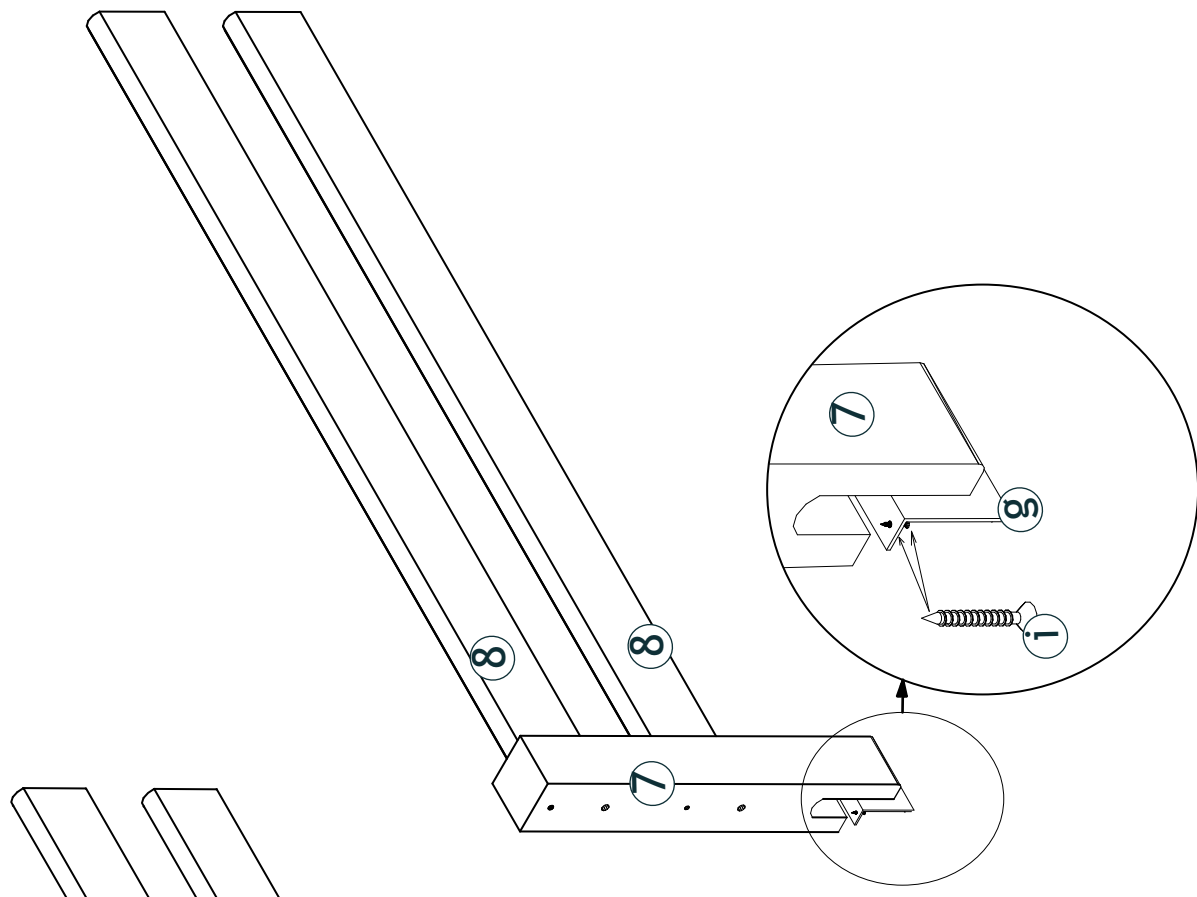

3.

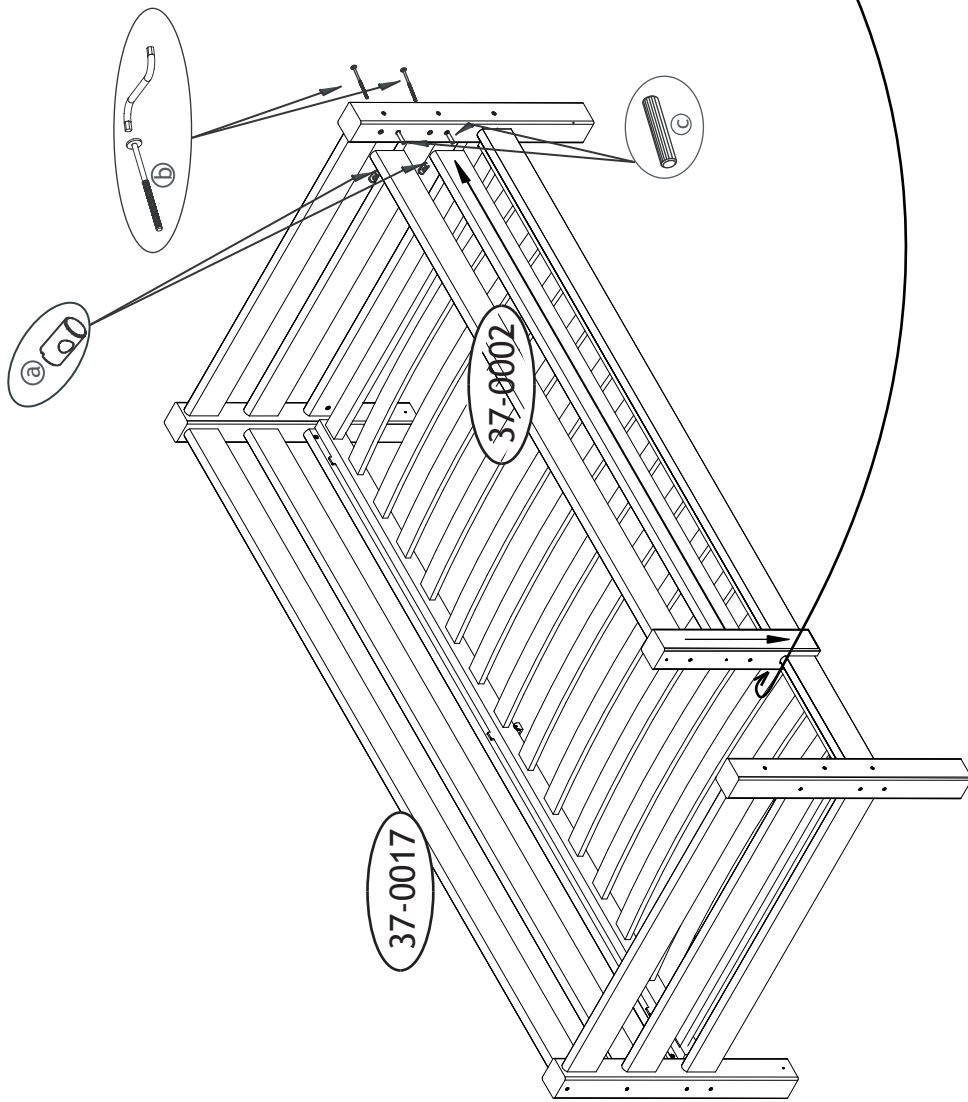

4.

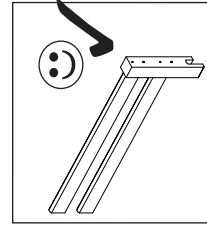
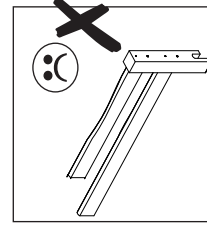
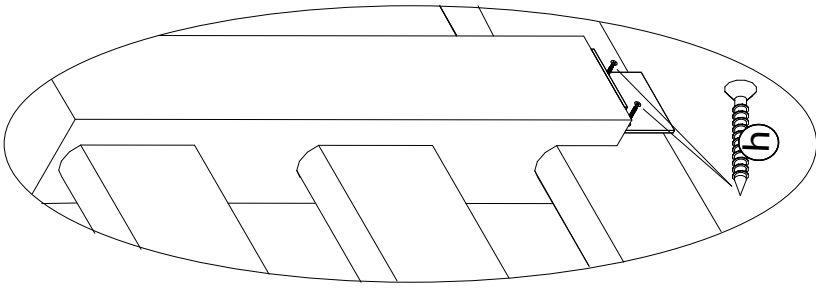

Close free holes with caps
 Luk alle huller med propper
 Schliessen Sie die offenen Löcher mit den Deckkappen
 Fermez les trous découverts avec les chapes



(UK) - Be aware of the risk of open fire and other heating sources close to the product
(DK) - Vær opmærksom på risikoen for åben ild og andre varmekilder i nærheden af produktet
(DE) - Berücksichtigen Sie die Gefahr des geöffneten Feuers und andere Wärmequellen nah an dem Produkt
(FR) - Ne pas placer le produit à proximité du feu ou du chauffage puissant