

TOP GUN



F-14A TOMCAT™

IN SERVICE - 1970 - PRESENT
PLACE OF ORIGIN - UNITED STATES
ROLE - CARRIER-BASED MULTI-ROLE STRIKE FIGHTER
CREW - TWO: PILOT AND RADAR INTERCEPT OFFICER
WINGSPAN - SPREAD: 19,55_m (64'),
 SWEPT: 11,58_m (38')
LENGTH - 19,1_m (62'9")
HEIGHT - 4,88_m (16')
WEIGHT - 19,838_{kg} (43,735_{lb})
ENGINE - 2 x PRATT & WHITNEY TF30 TURBOFANS
RANGE - 2960_{km} (1600_{mi})
RATE OF CLIMB - 229_{M/SSEK} (45,000_{FT/MIN})
MAXIMUM FLIGHT LEVEL - 15,000_m (49213_{ft})
SPEED - 2485_{km/h} (1544_{mph})
ARMAMENT - AIR-TO-AIR MISSILE,
 MK-61A1 VULCAN CANNON,
 AIR-TO-GROUND ORDNANCE



TM & © 2023 Paramount Pictures. All Rights Reserved

NORTHROP GRUMMAN

F-14A TOMCAT® is a registered trademark of Northrop Grumman Systems Corporation and is used under license by COBI.

5811 A



Printed in EU

scale
1:48

F-14A TOMCAT™

757  2 



PEFC Certified
This product is from sustainably managed forests and controlled sources
www.pefc.org



WARNING: CHOKING HAZARD-
Toy contains small parts.
Not for children under 3 years.

1

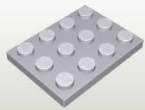
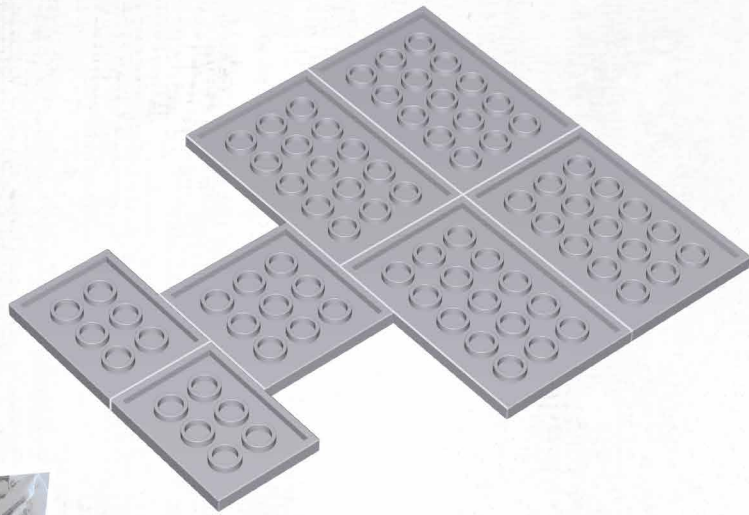

x2



x1



x4

2

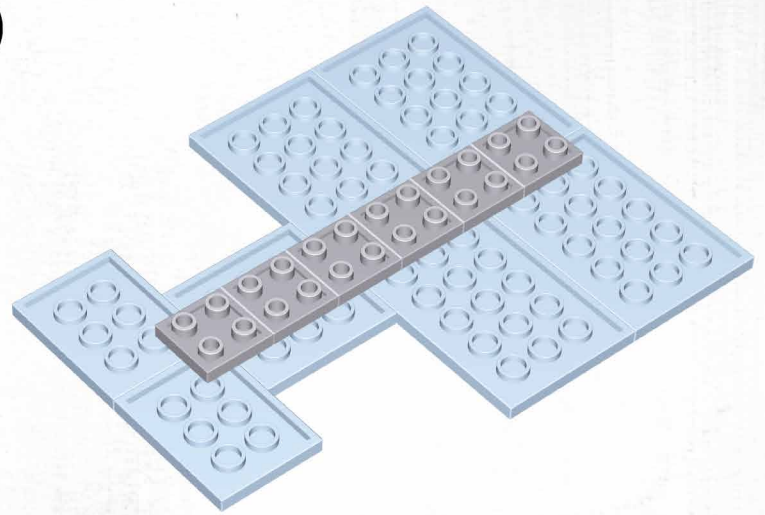

x6

3



x12

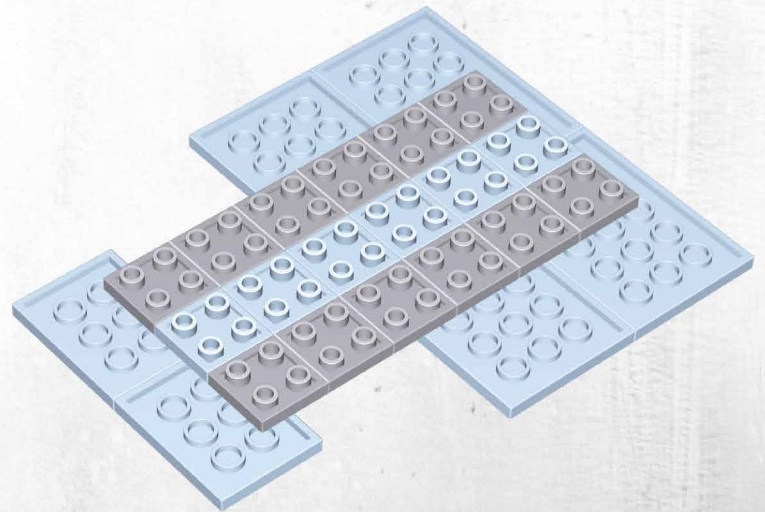

4

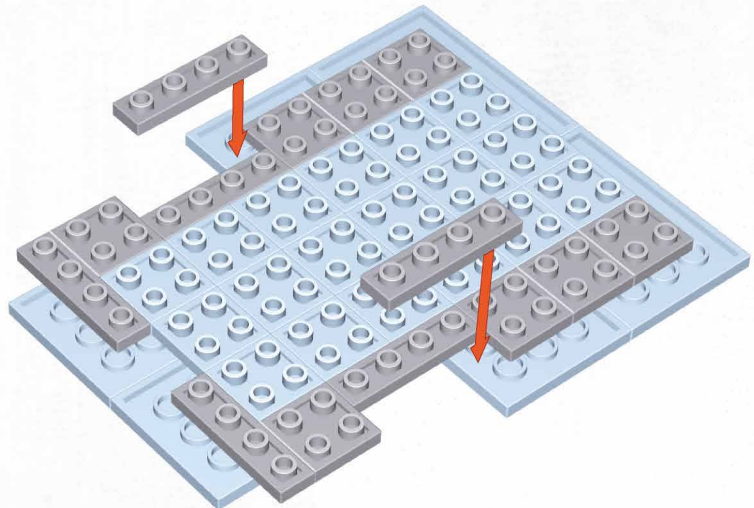

1x2 grey Technic beam x8

1x6 grey Technic beam x6

5

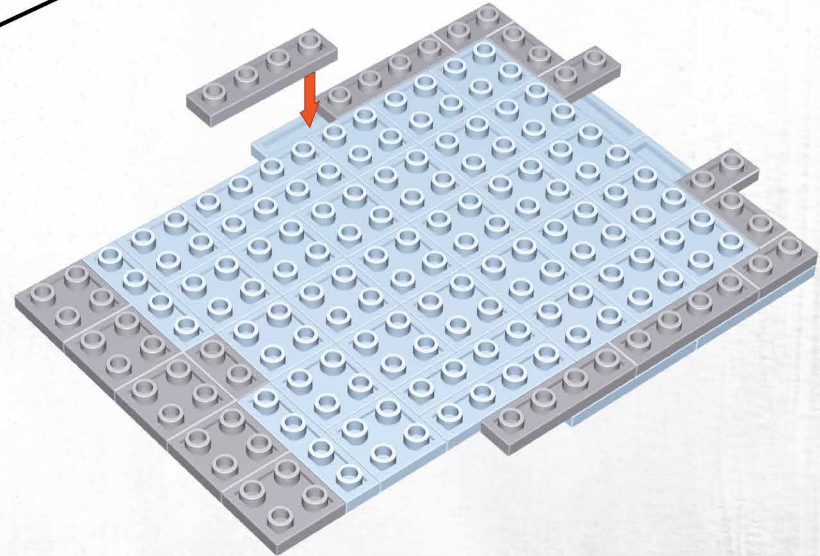

1x2 grey Technic beam x7

1x6 grey Technic beam x4

1x2 grey Technic beam x5

6

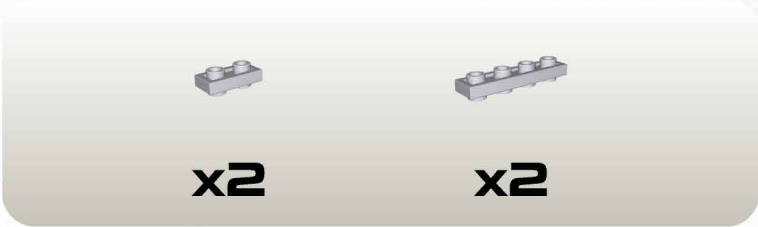
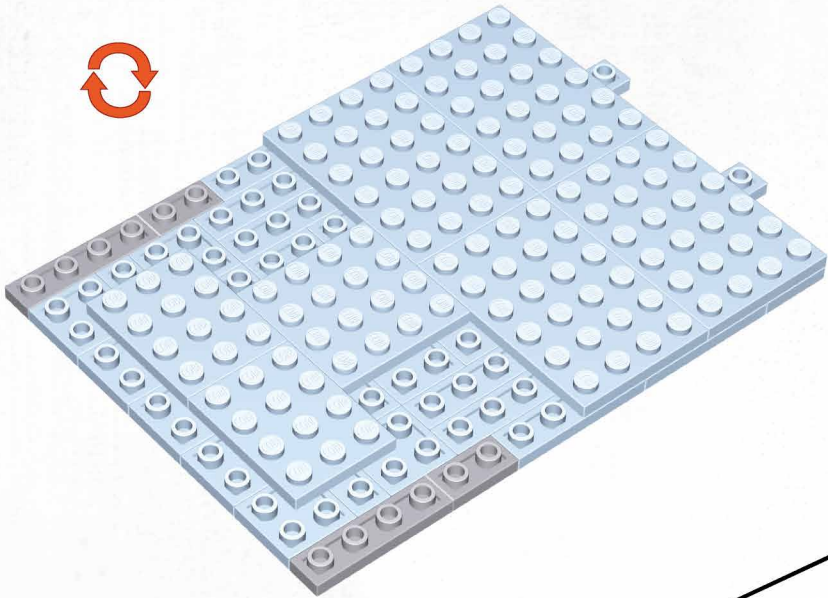

7

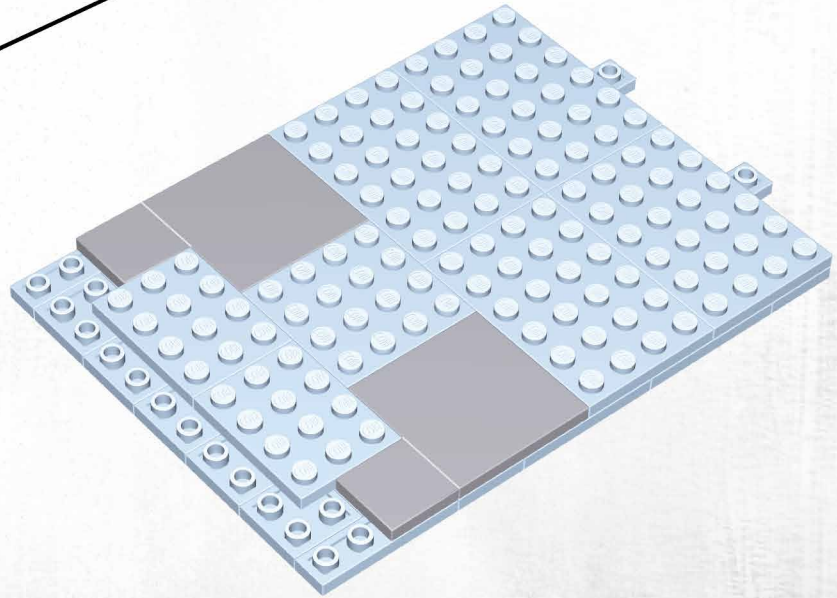

8

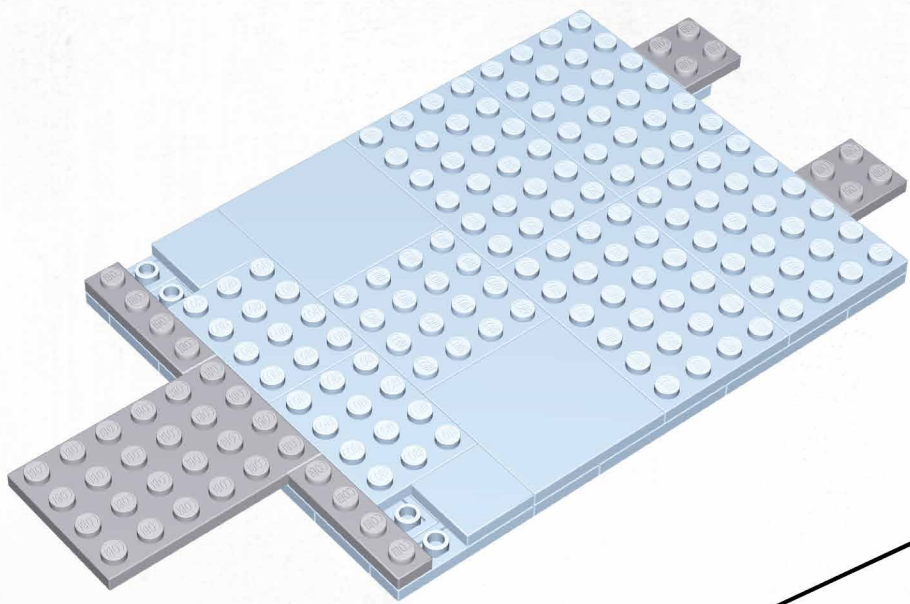

x2 x1 x2

9

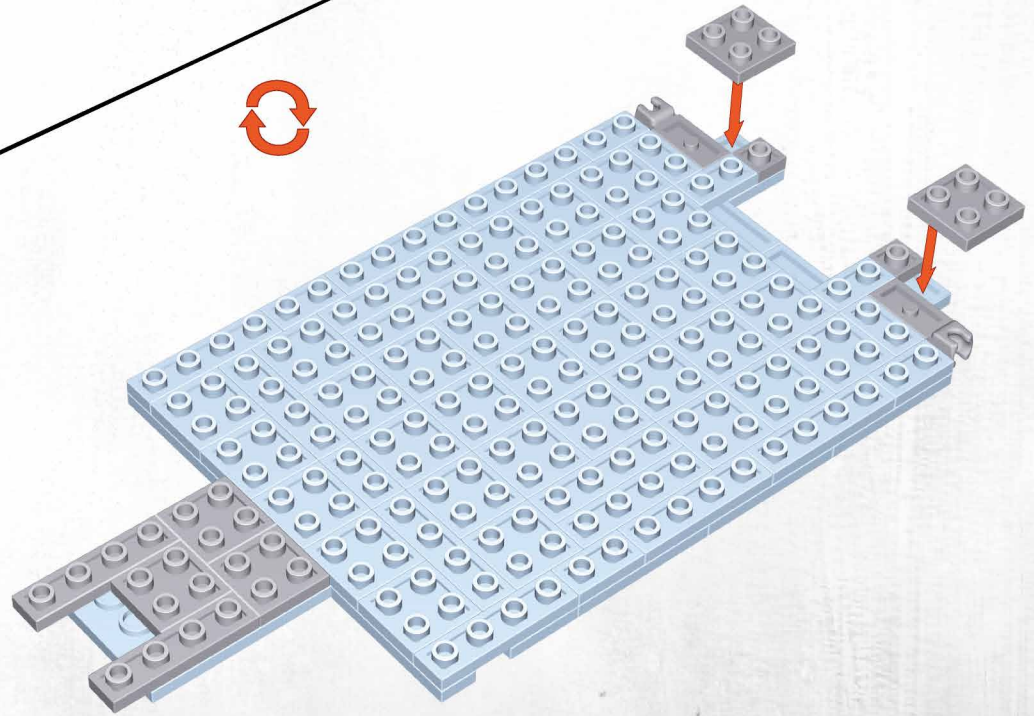

x2 x2 x2 x5

10

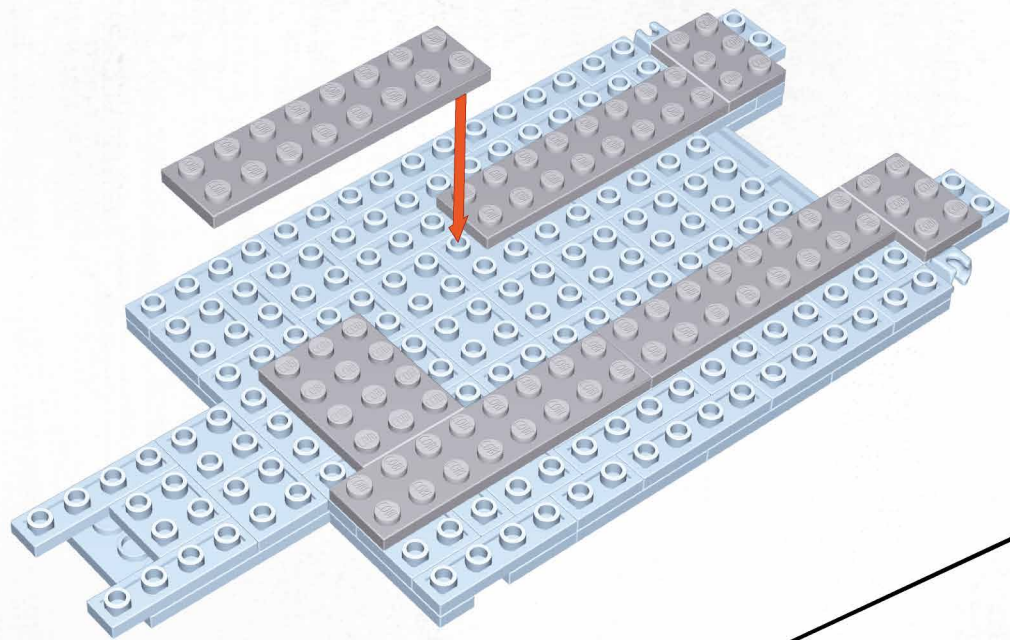
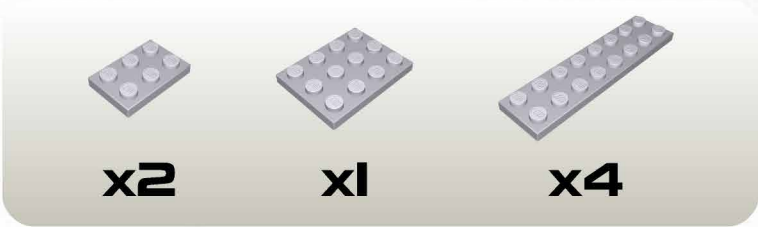

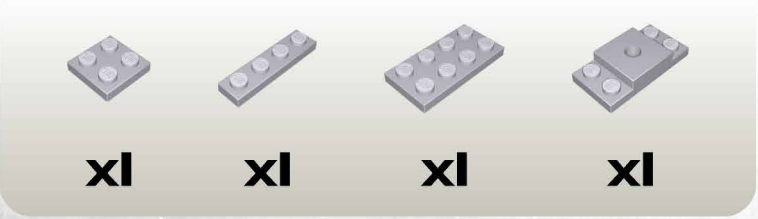
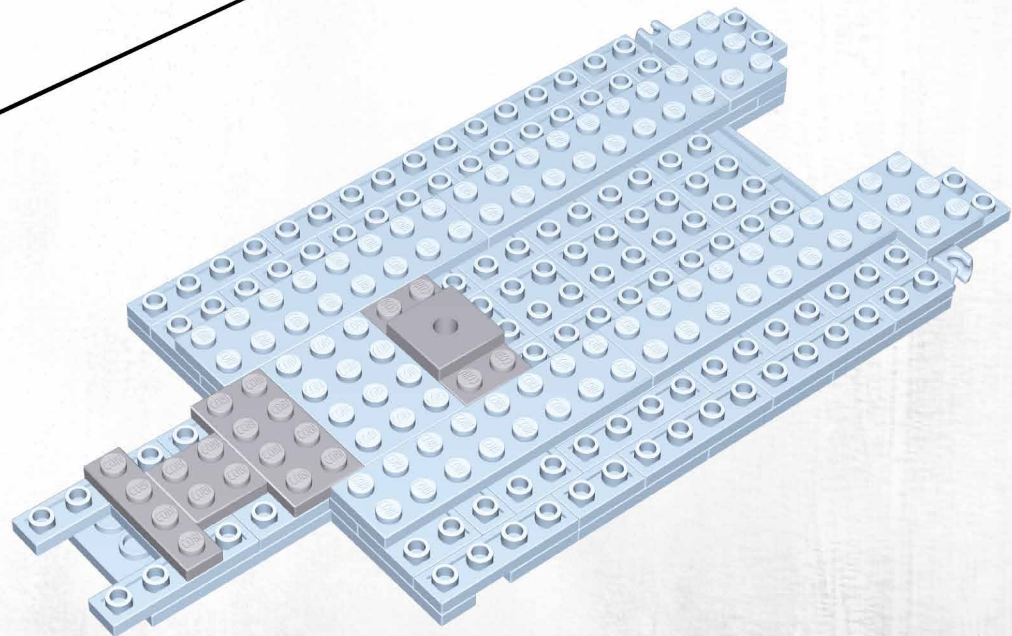

11



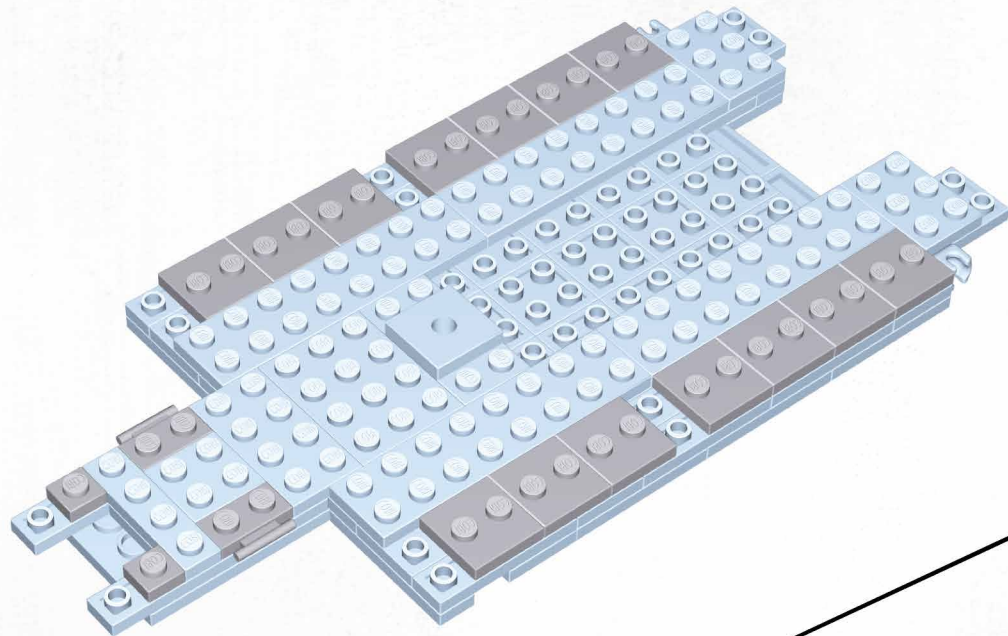





12

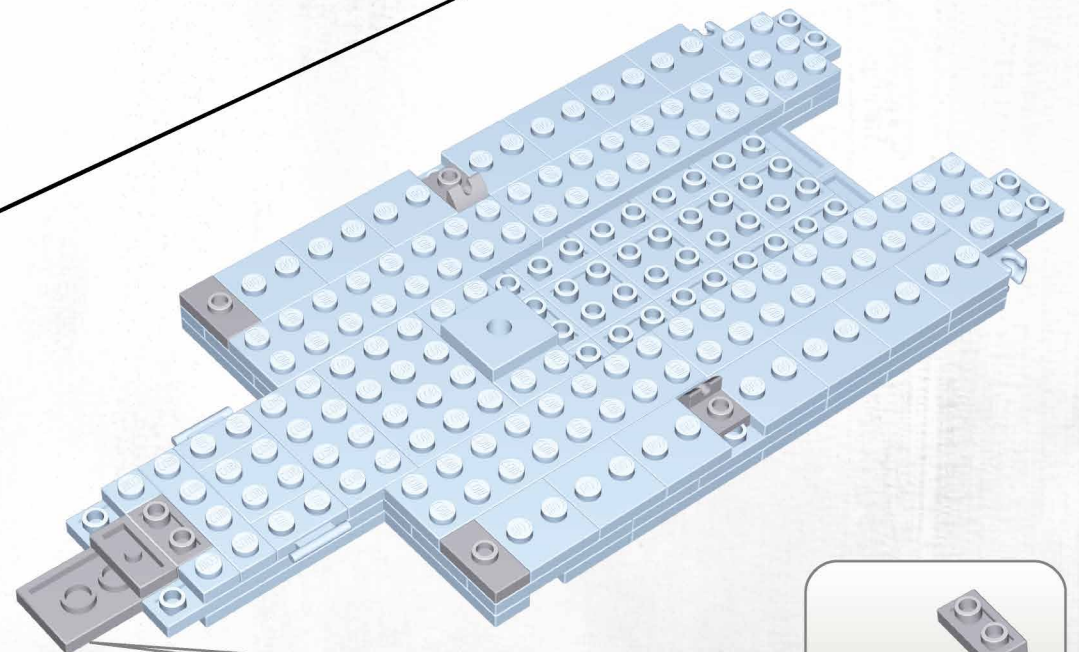





x14 **x2** **x2**

13

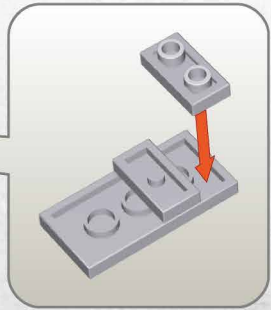







x1 **x1** **x2** **x1** **x2**

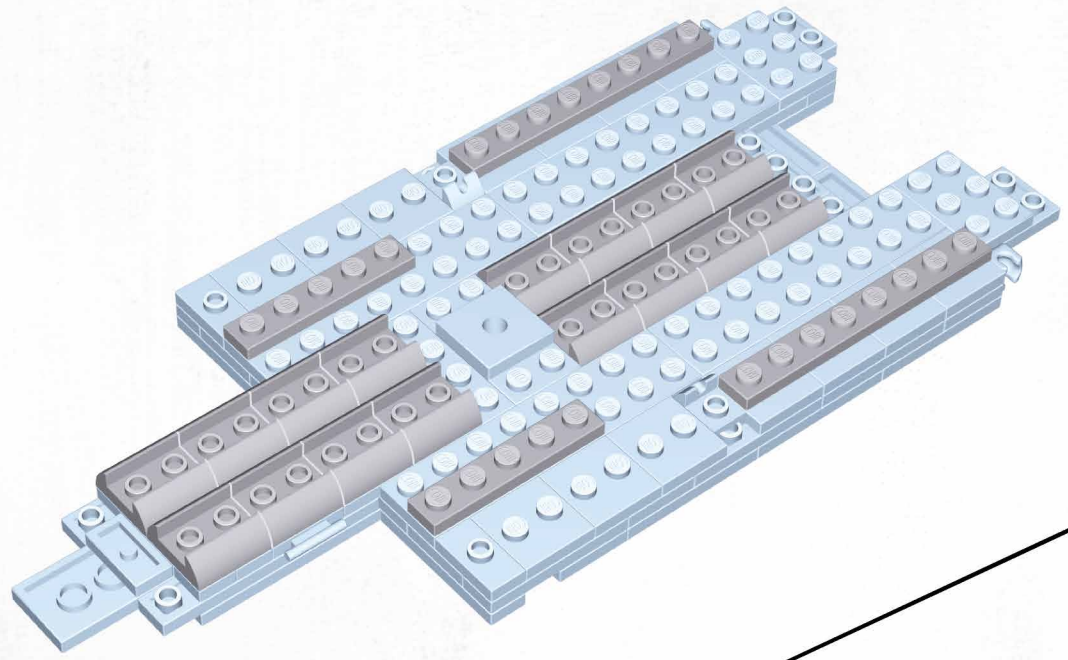

14



x16 x2 x2







15

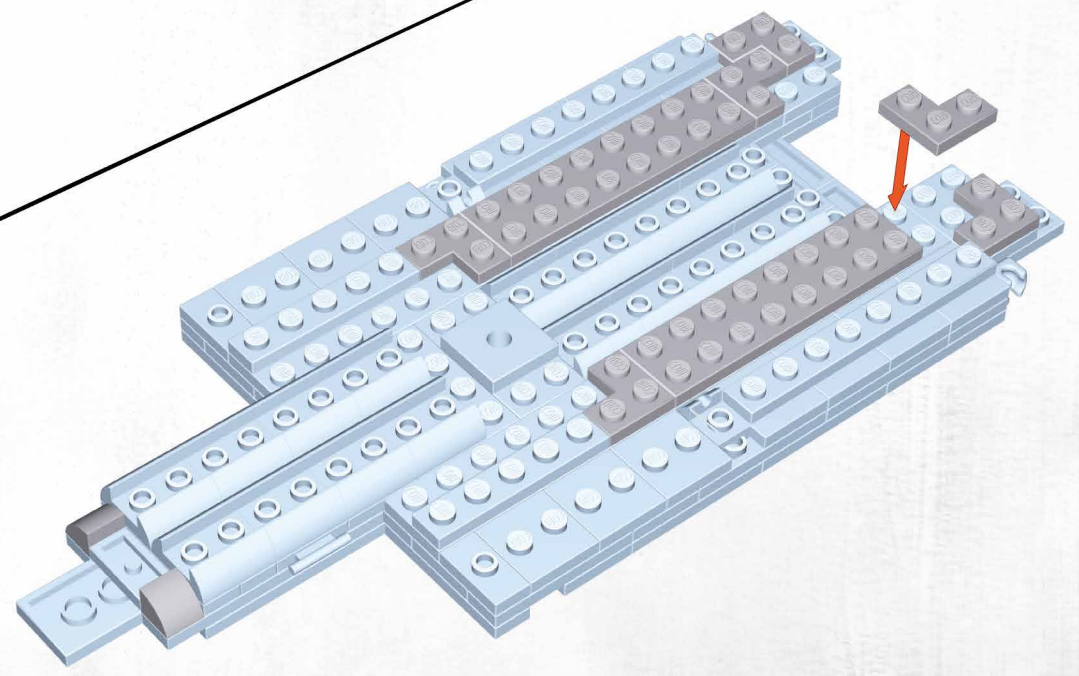

x2 x2 x6





16

			
x4	x8	x2	x2

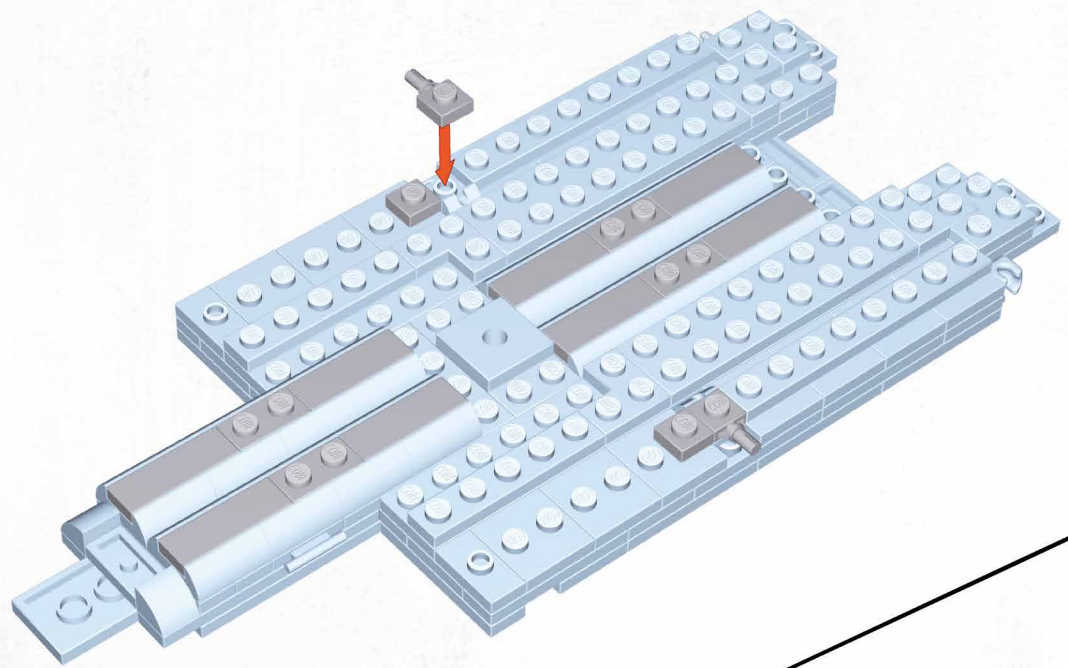
1:1



17

	
x10	x4

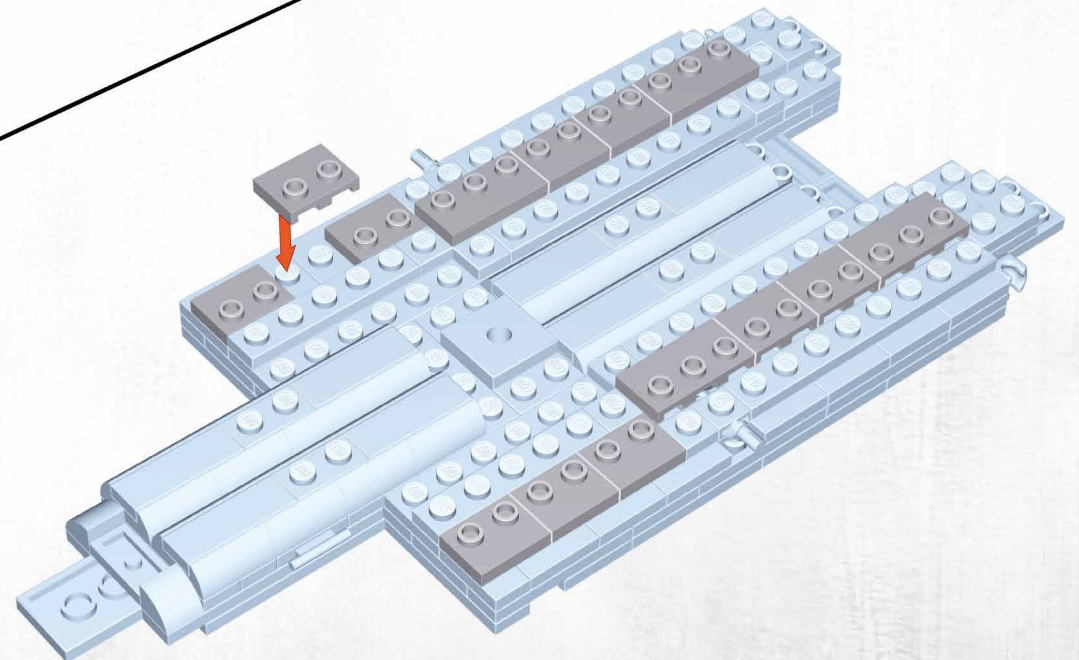

18

BE CAREFUL: NOTICE THE DIFFERENCE

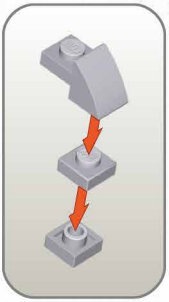
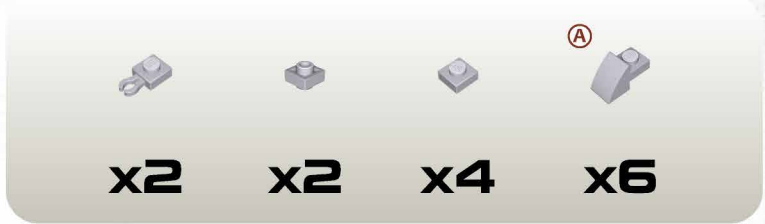
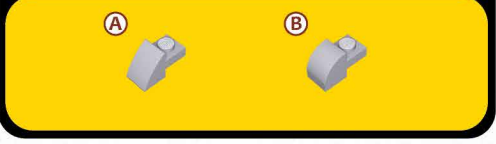

x2

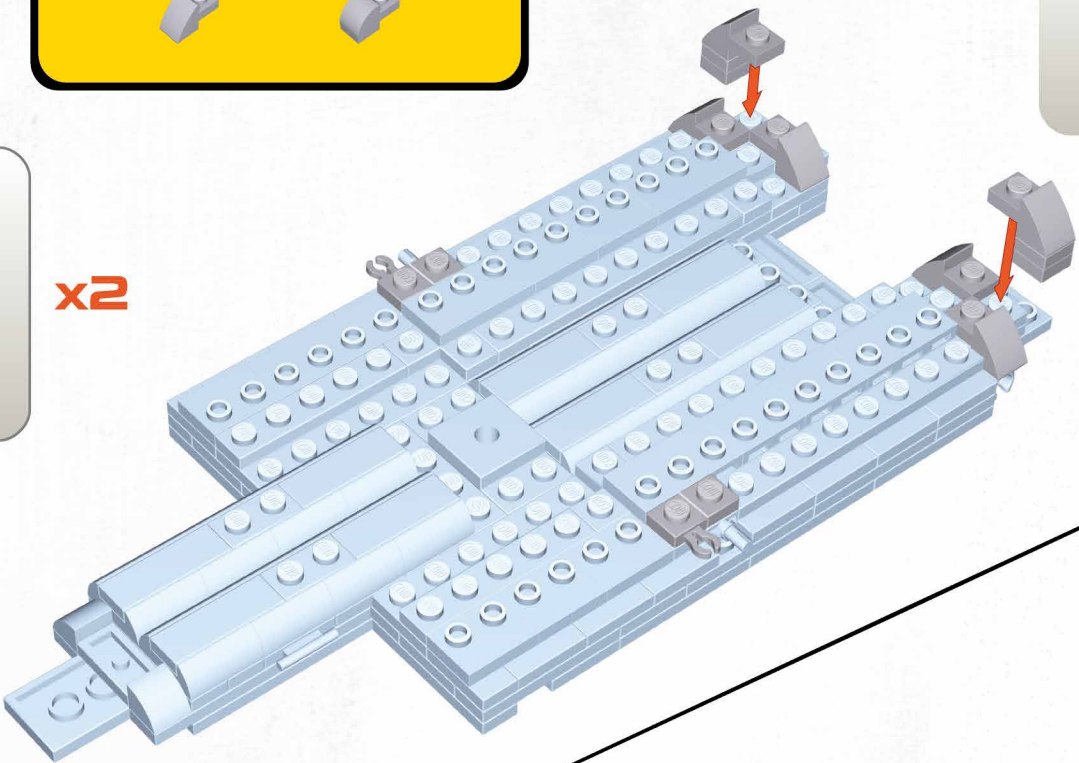

19

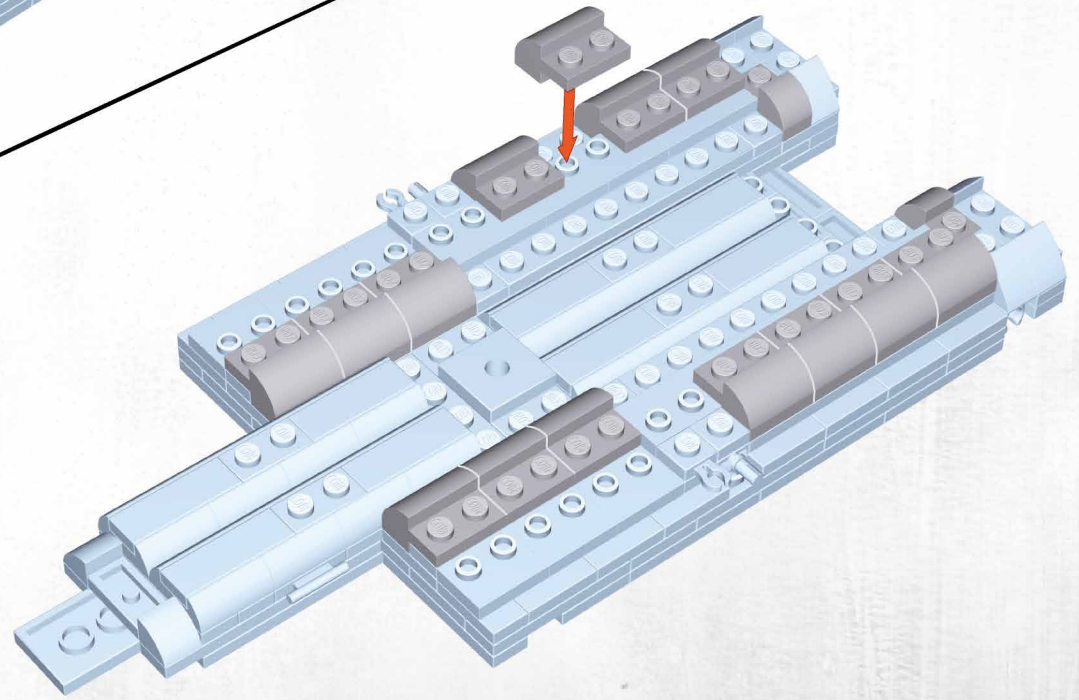

20

BE CAREFUL: NOTICE THE DIFFERENCE

C



D

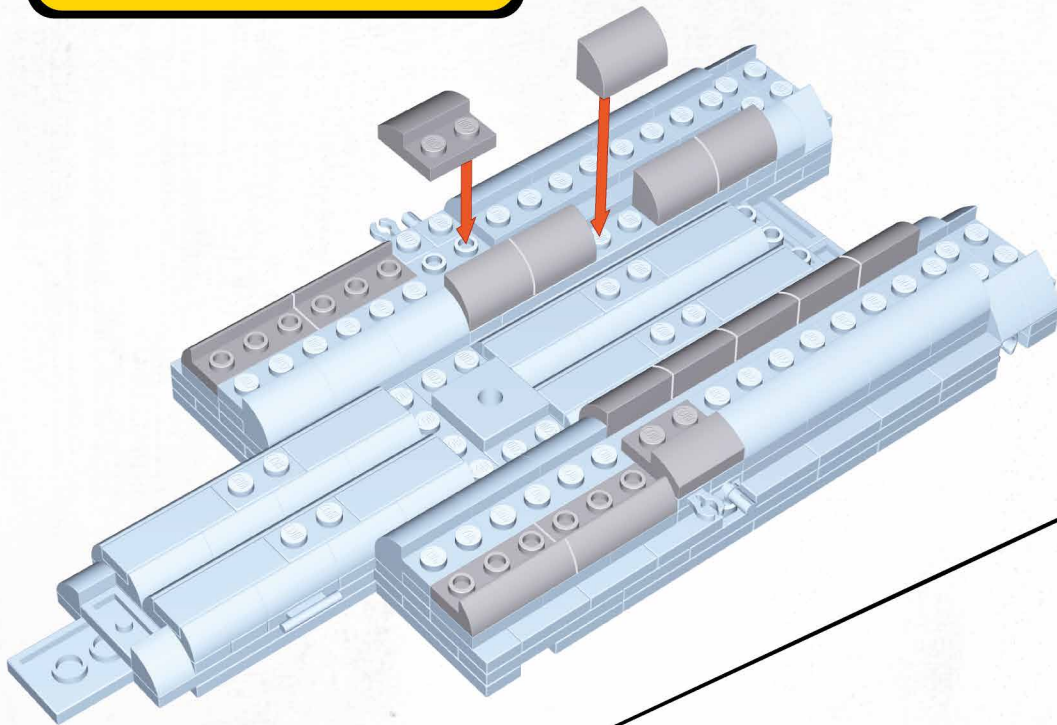

x4

C



x2



x10

21

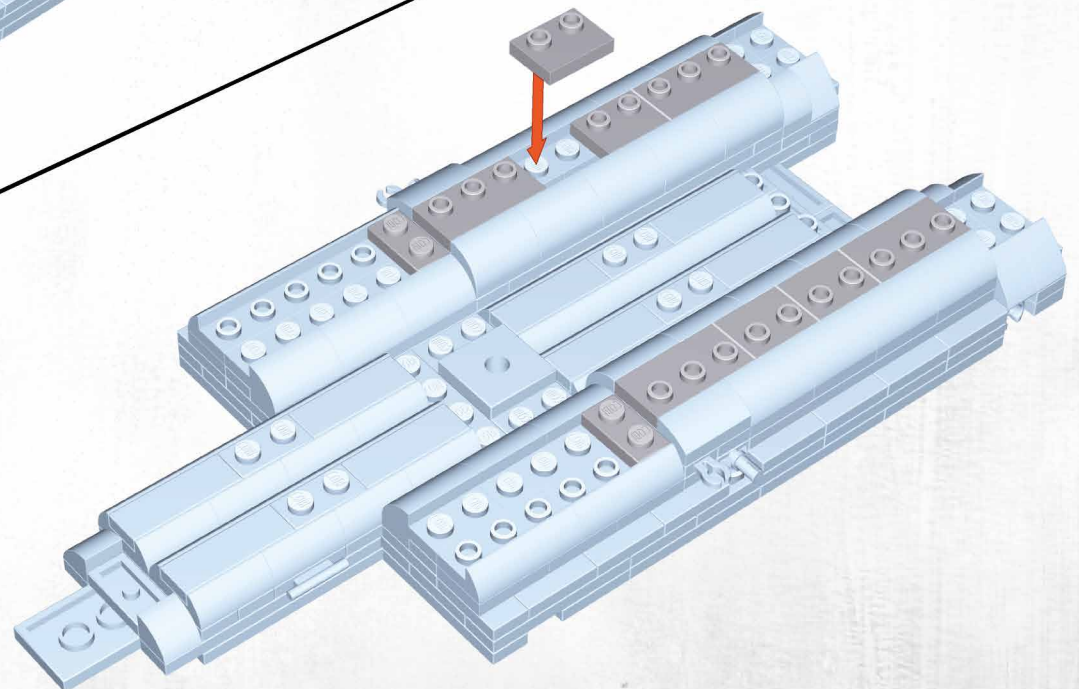

x4



x4



x2

22

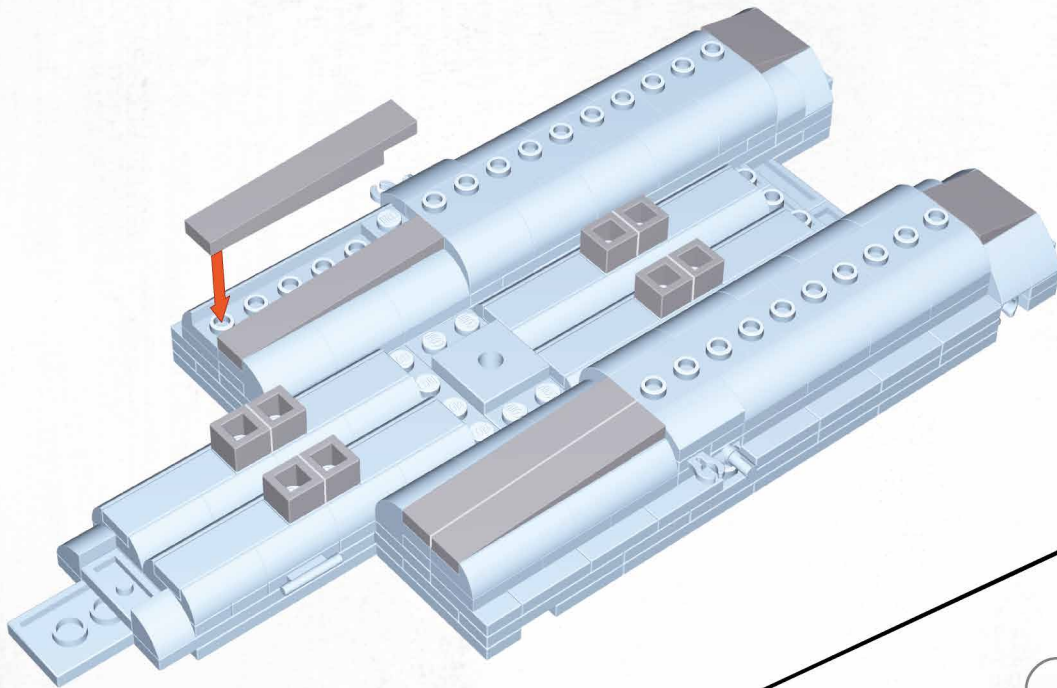

x4



x8



x2

23



x2



x2



x2

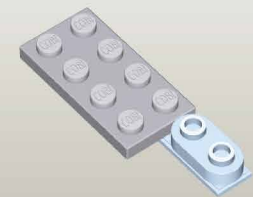
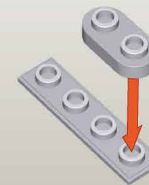



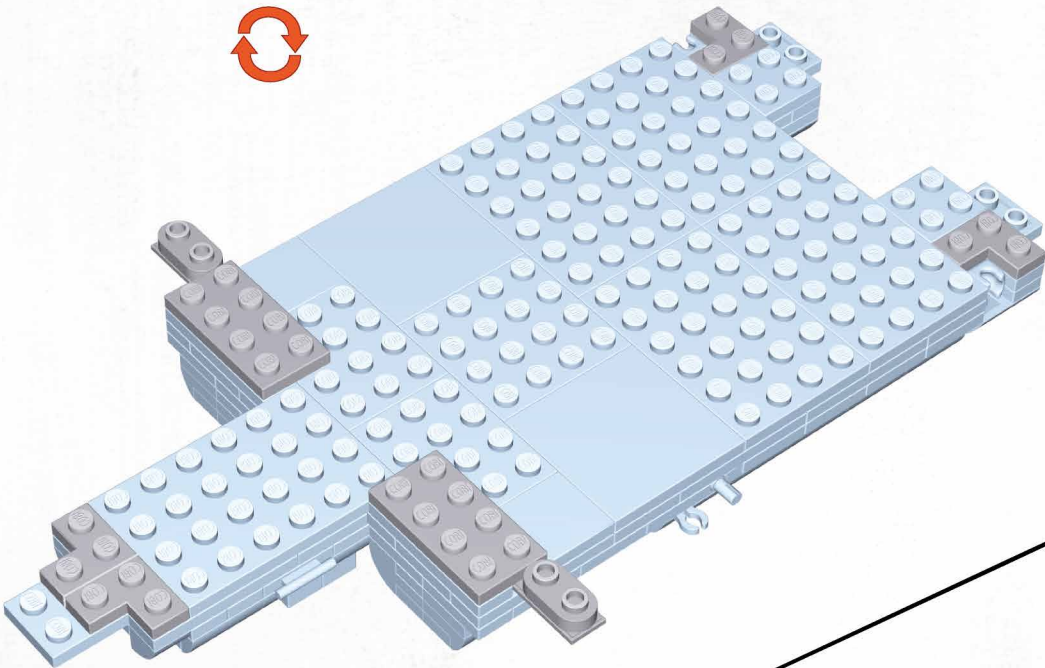

24



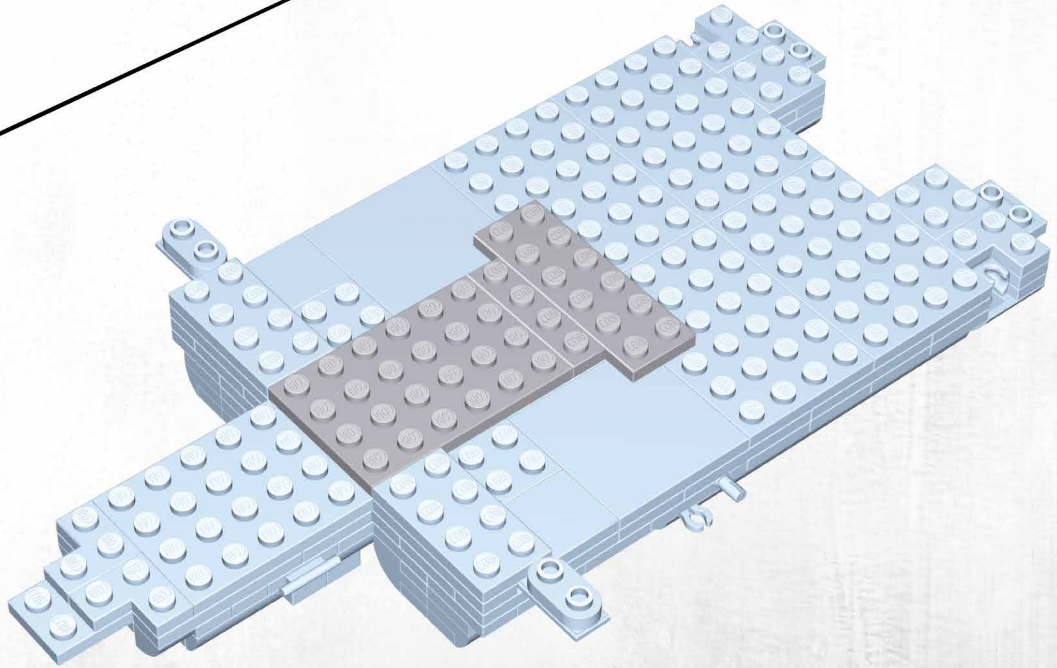

x4

25

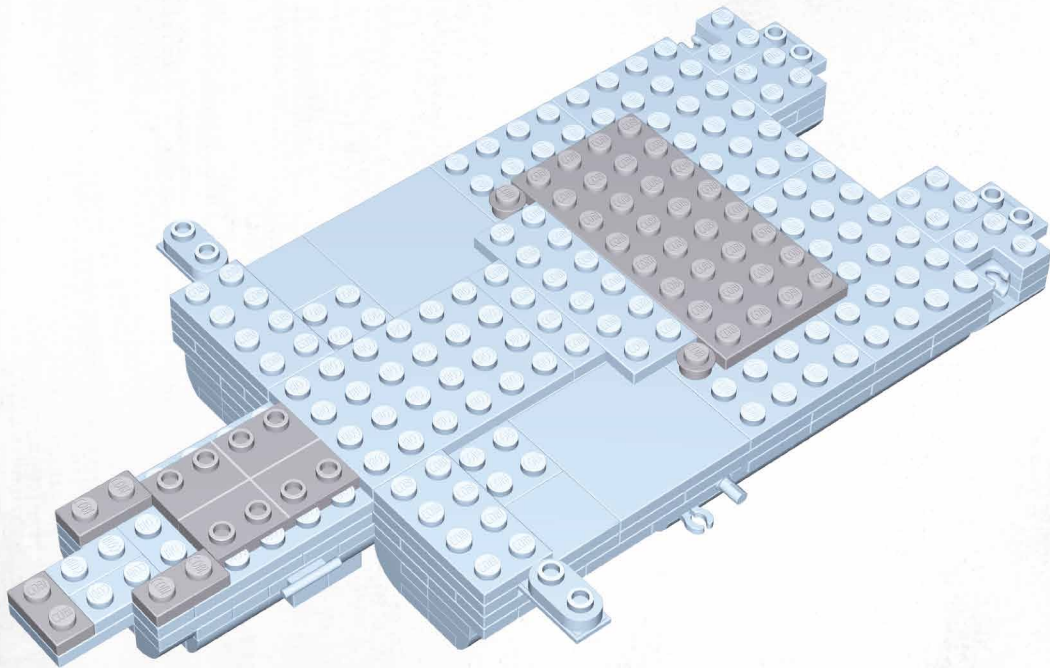

  
x1 x1 x1

26



x3



x4

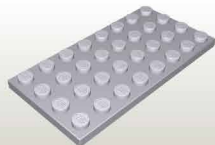

x1



x2

27



x2



x4



x2

28

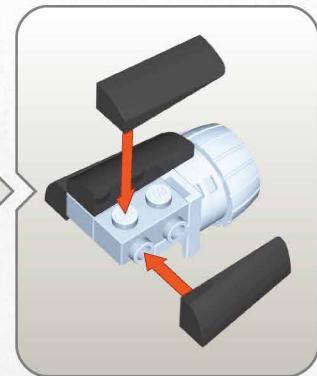
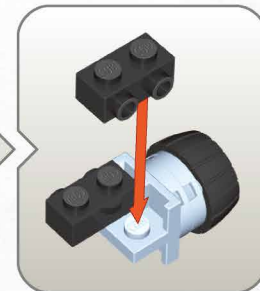
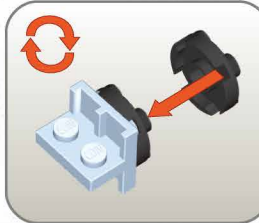

x2



x4



x4



x2



x4



x4

29

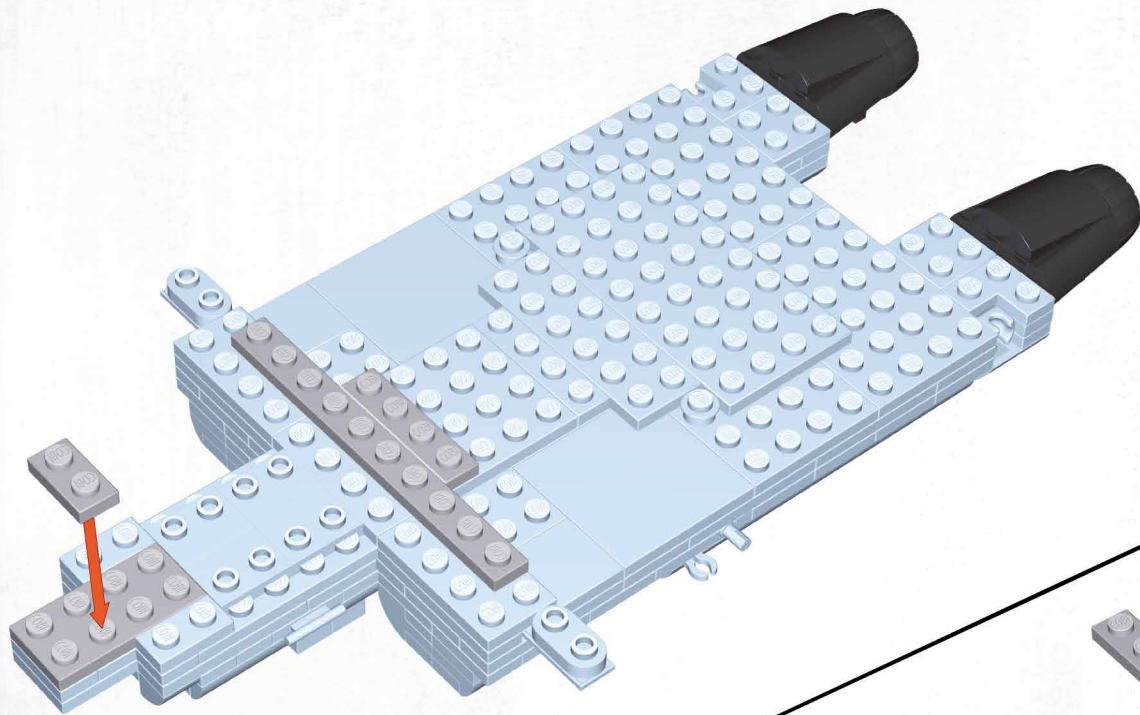

x1



x1

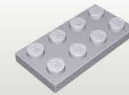

x1



x1

30

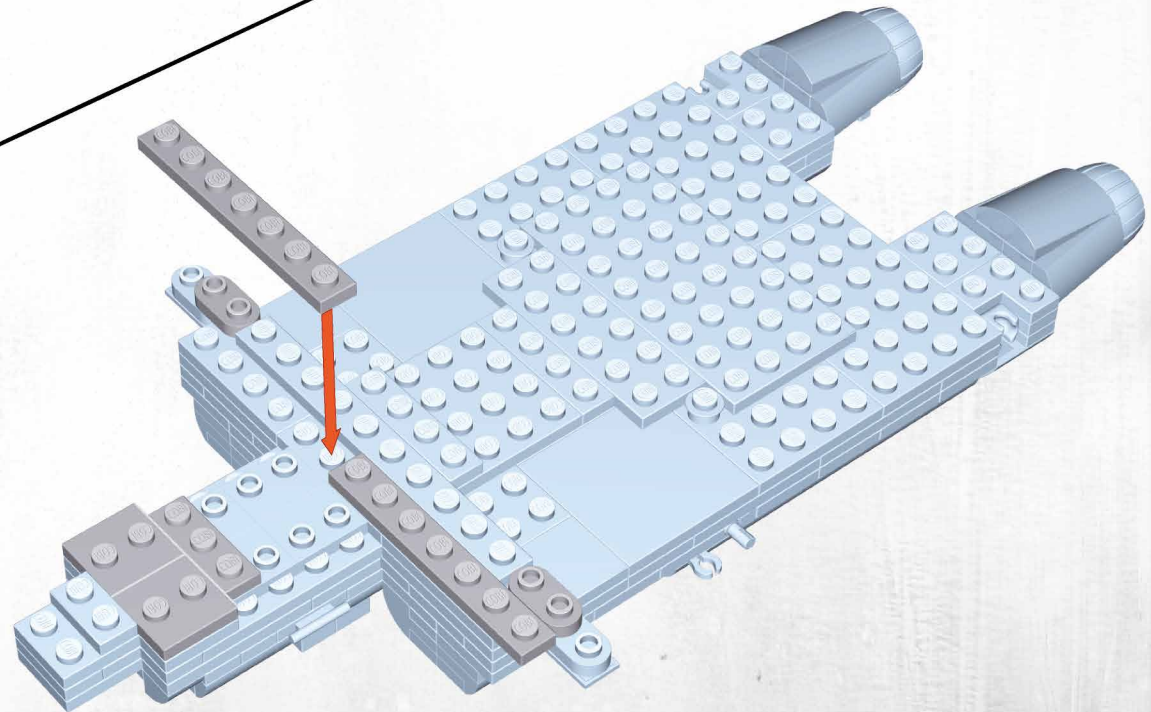

x2



x1



x2



x2

31

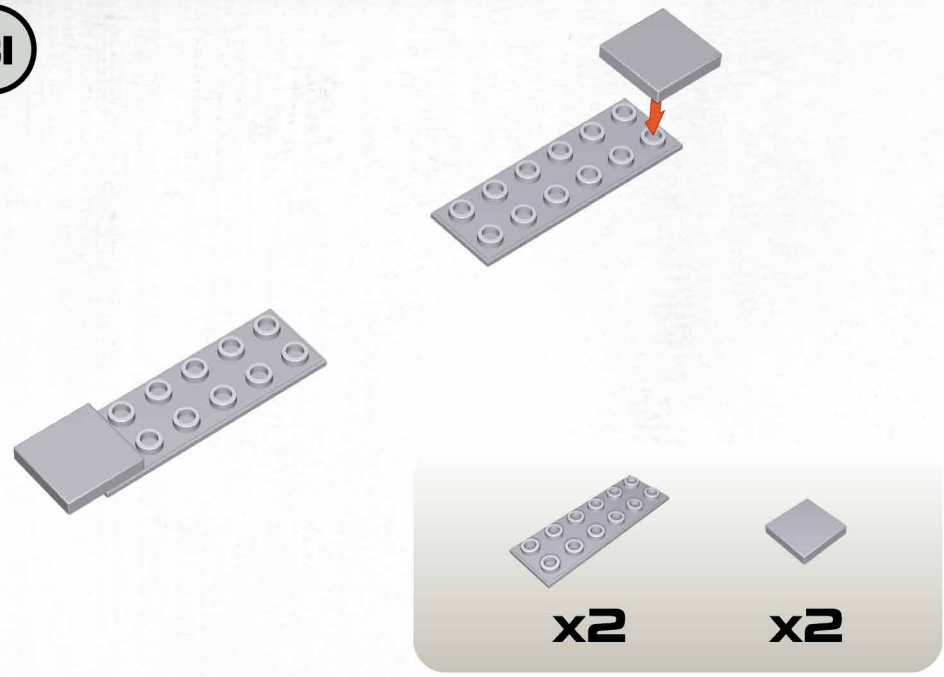

32

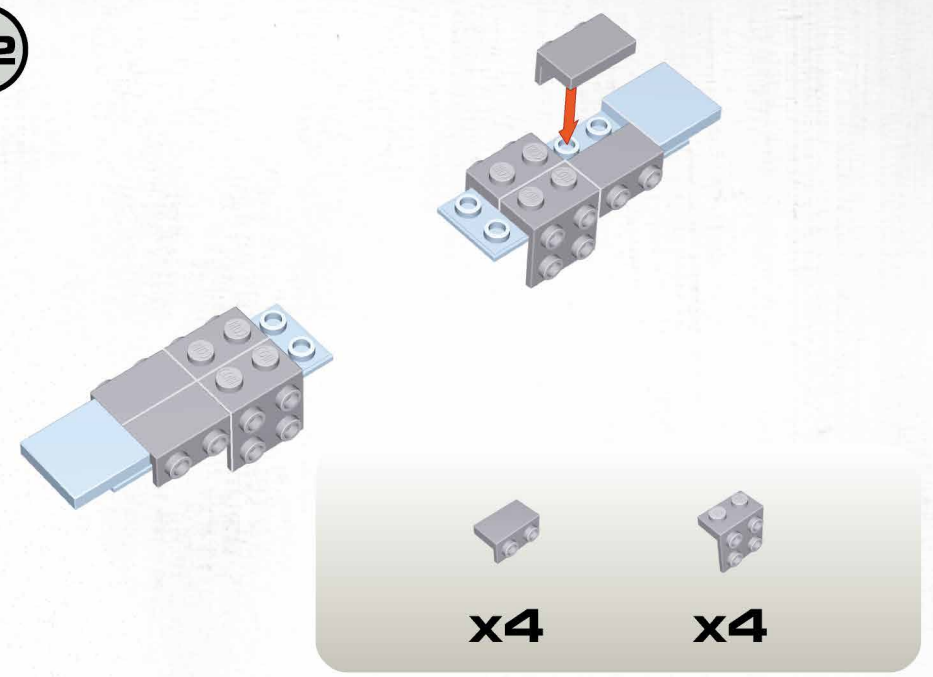

33

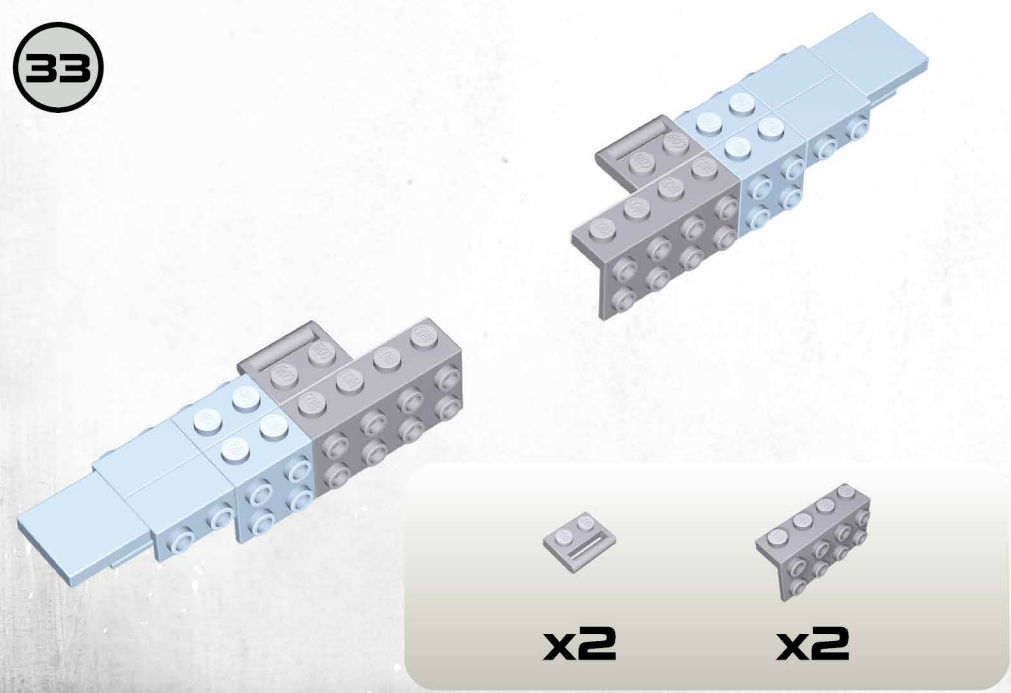

34

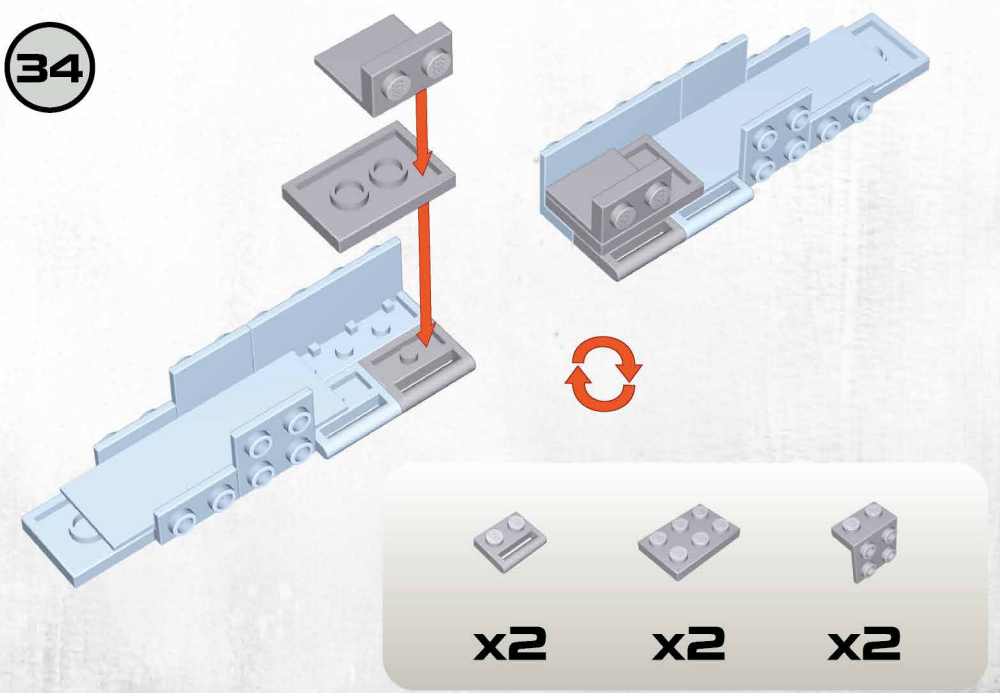

35

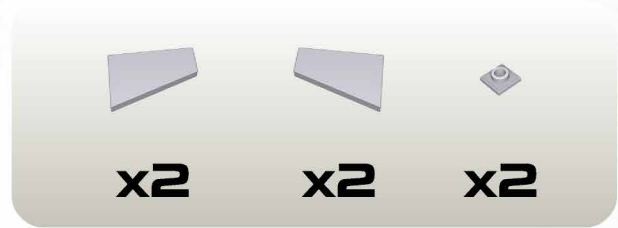
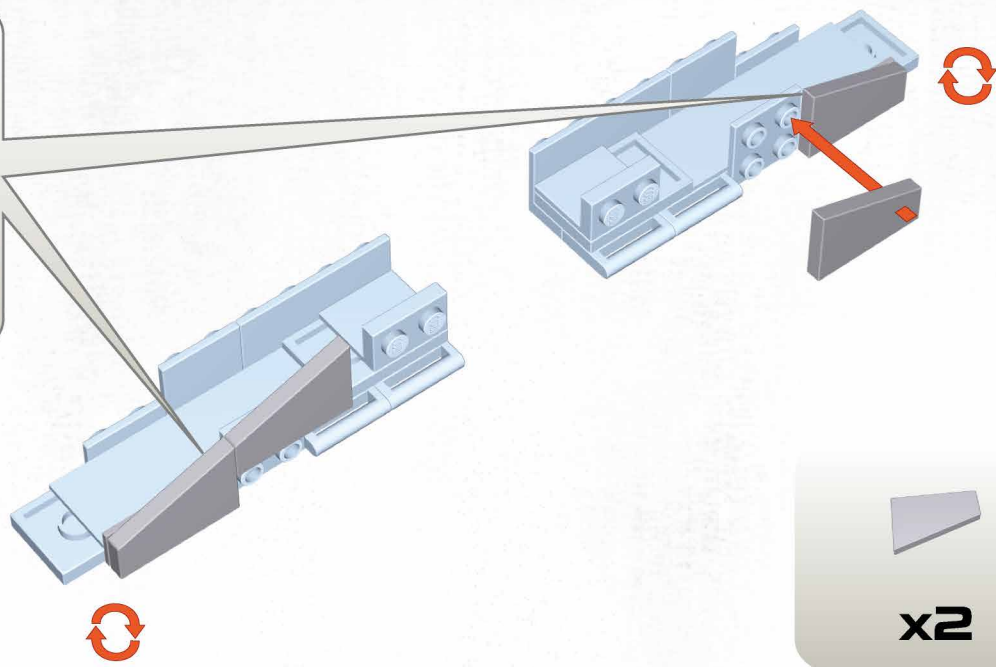
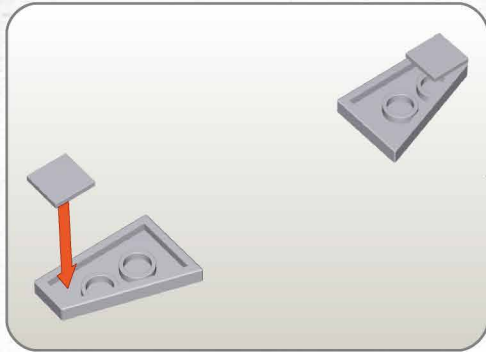



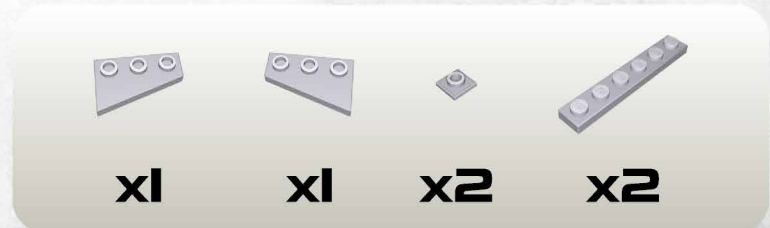
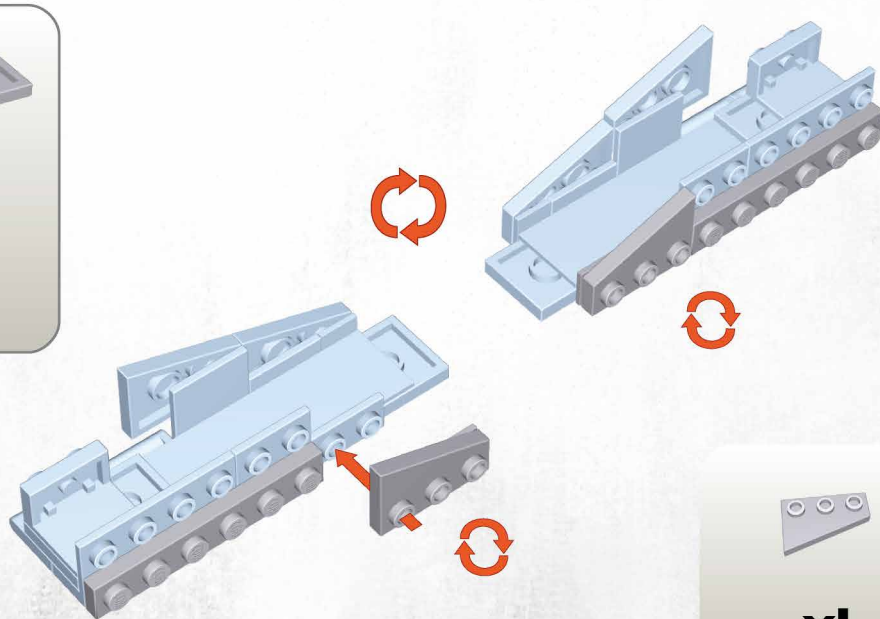
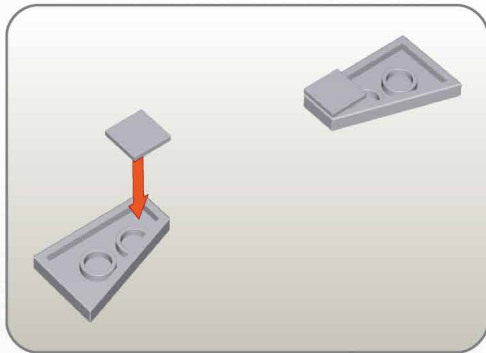

36

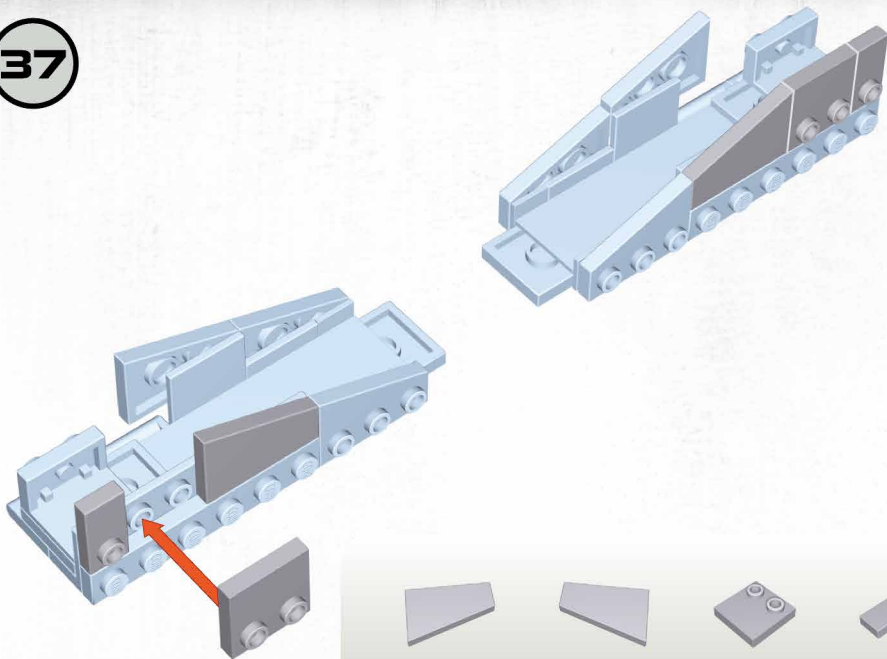





37

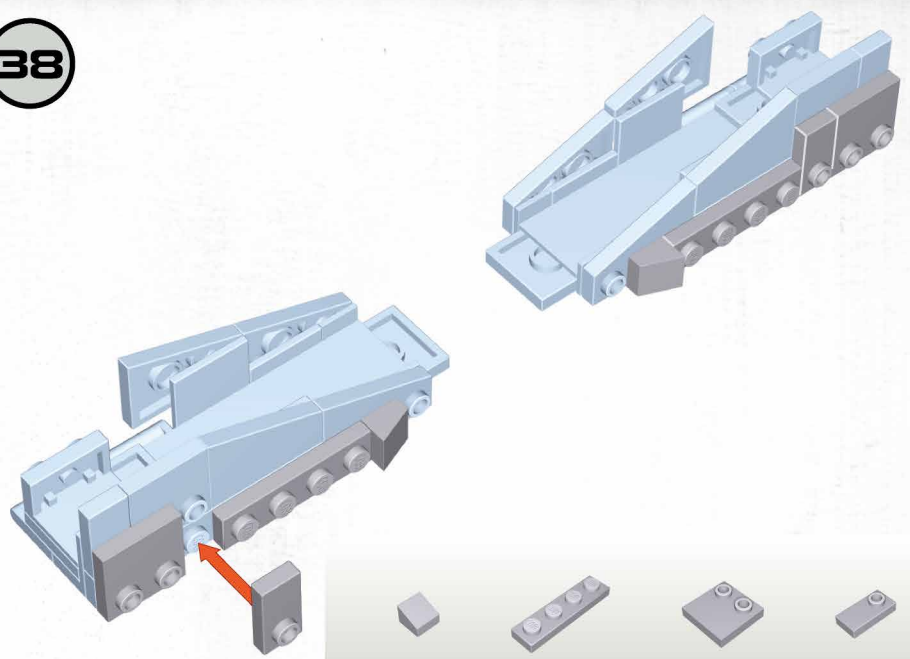

- 
x1
- 
x1
- 
x2
- 
x2

38



- 
x2
- 
x2
- 
x2
- 
x2

39

- 
x2
- 
x4

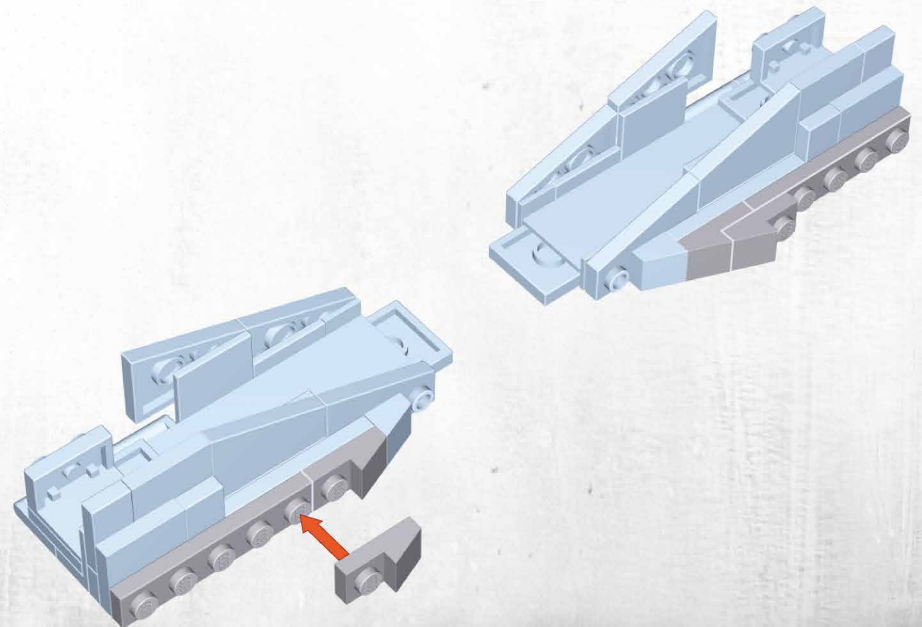

40

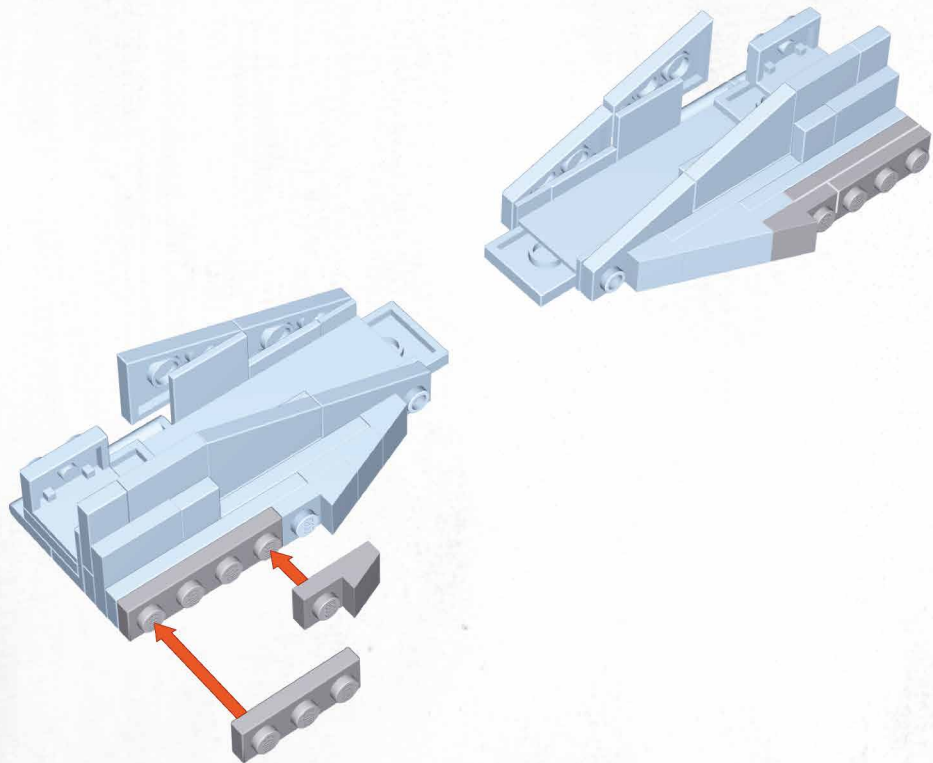

x2



x2



x2

41

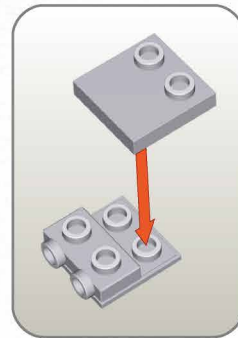

x2

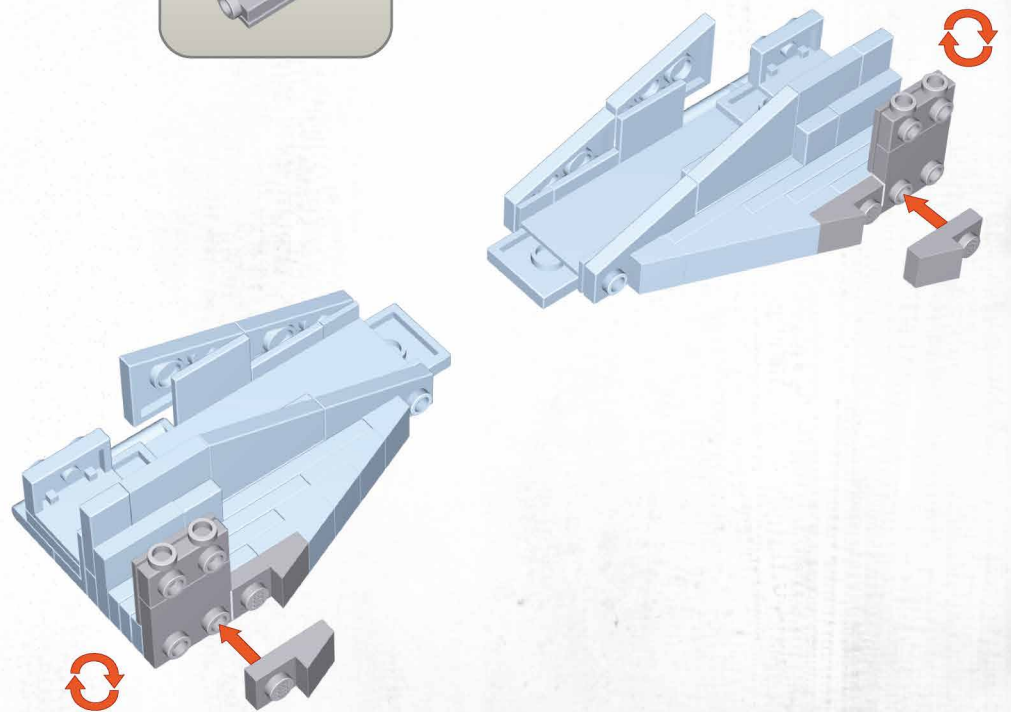

x2



x2



x2



x4

42

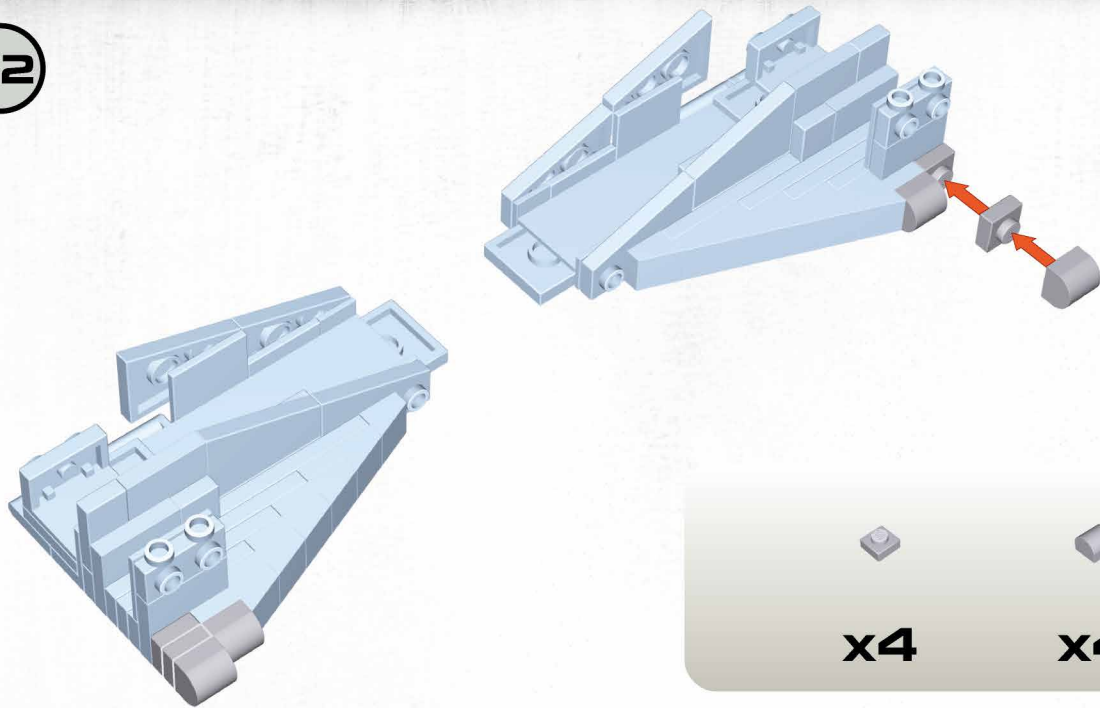

x4

x4

43-46 x2

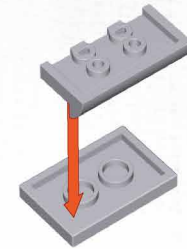

x1

x1

44

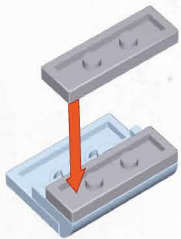

x2

45

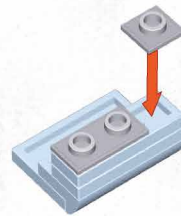

x1

x1

46

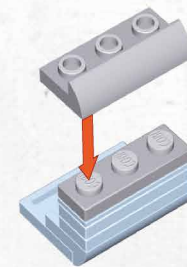

x1

x1

47

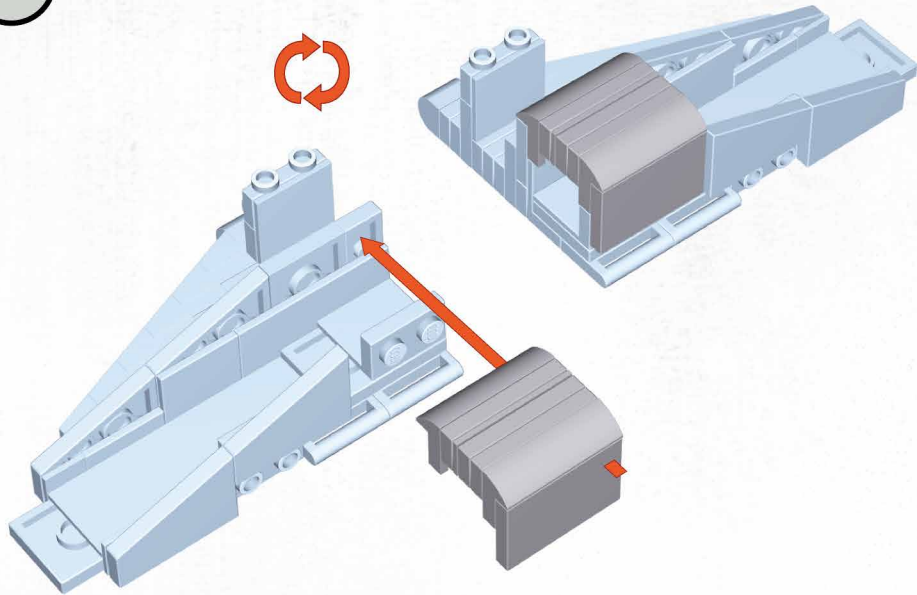

48

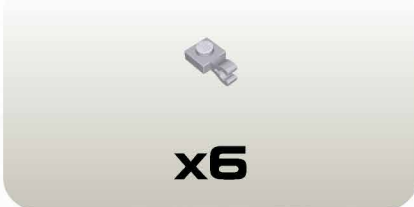
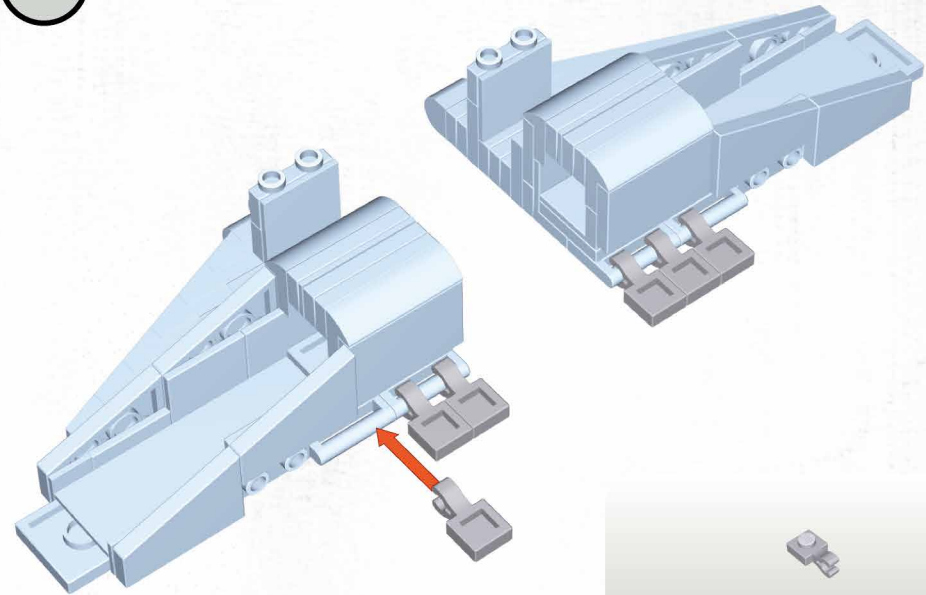

49

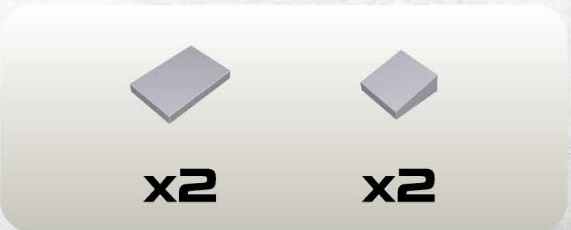
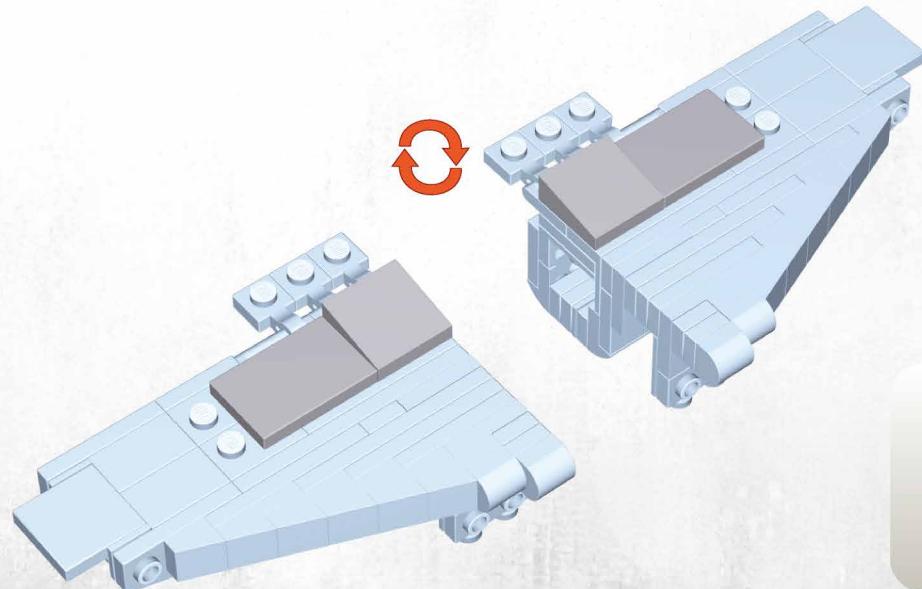

50

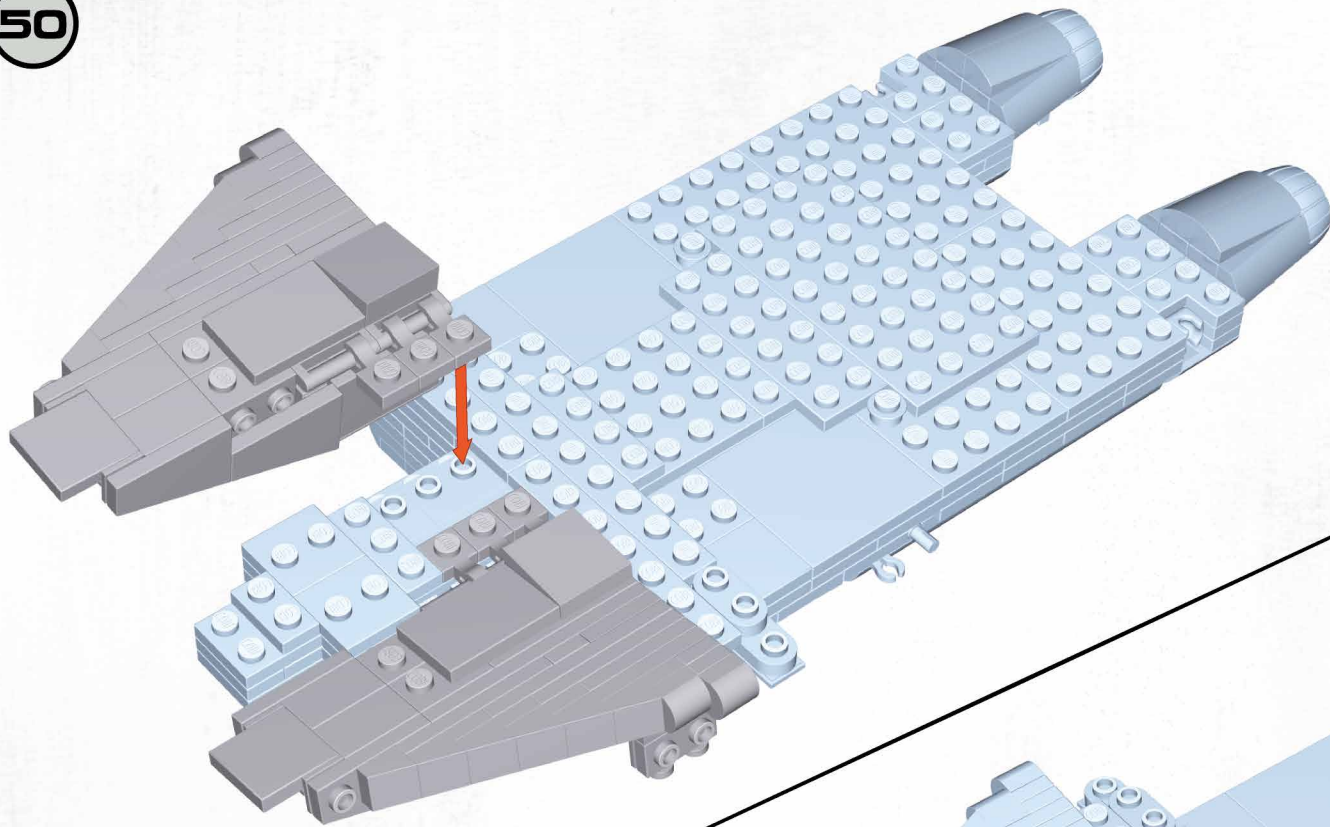

51

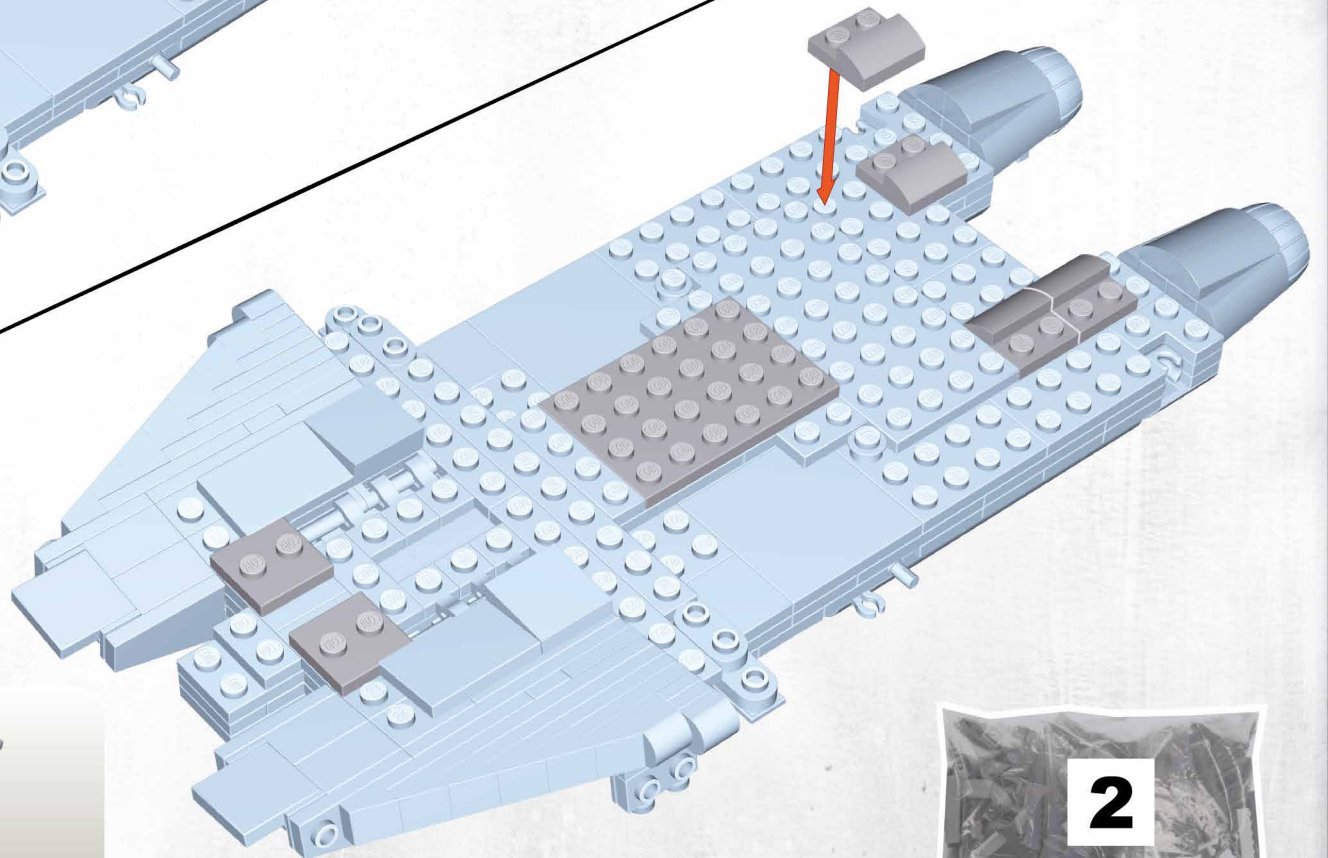

x2



x4

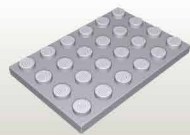

x1



52

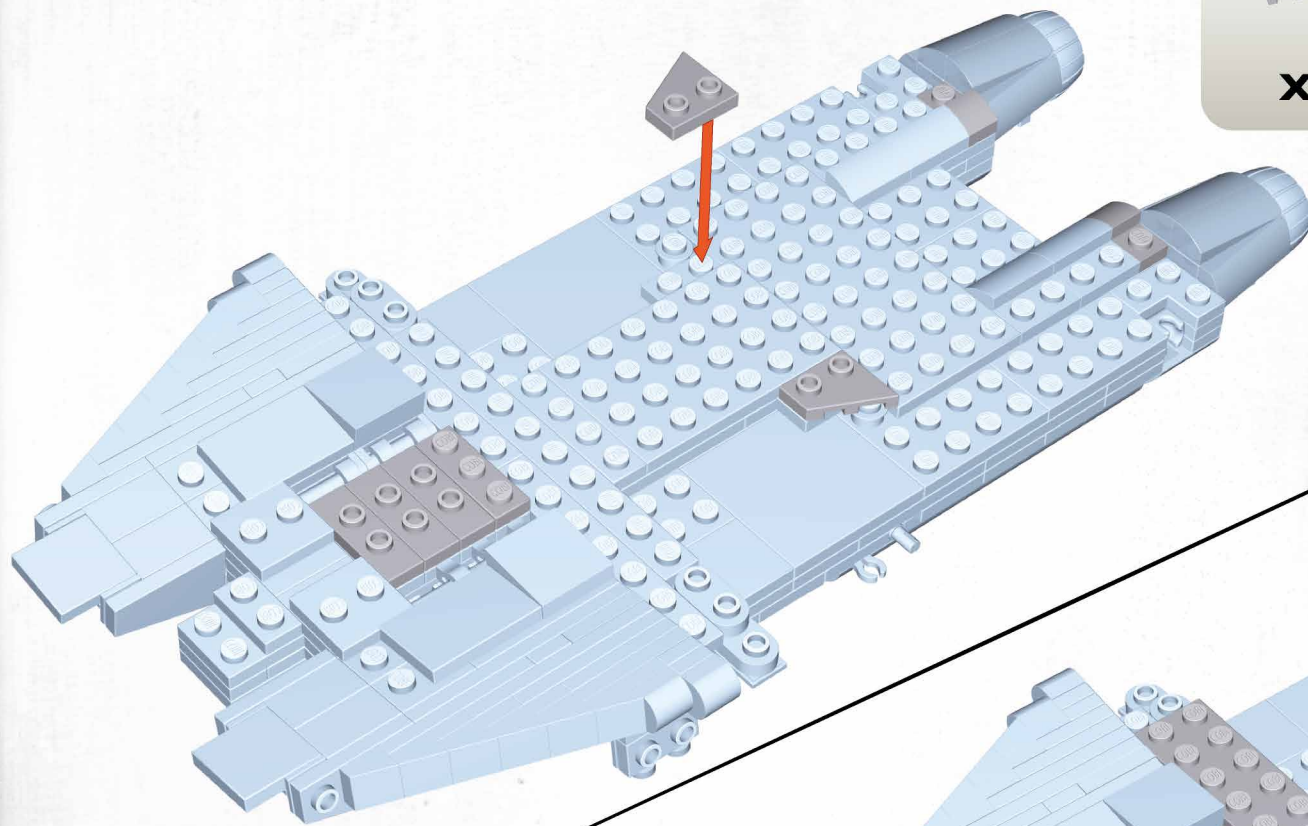

x1	x1	x2	x1	x3

53

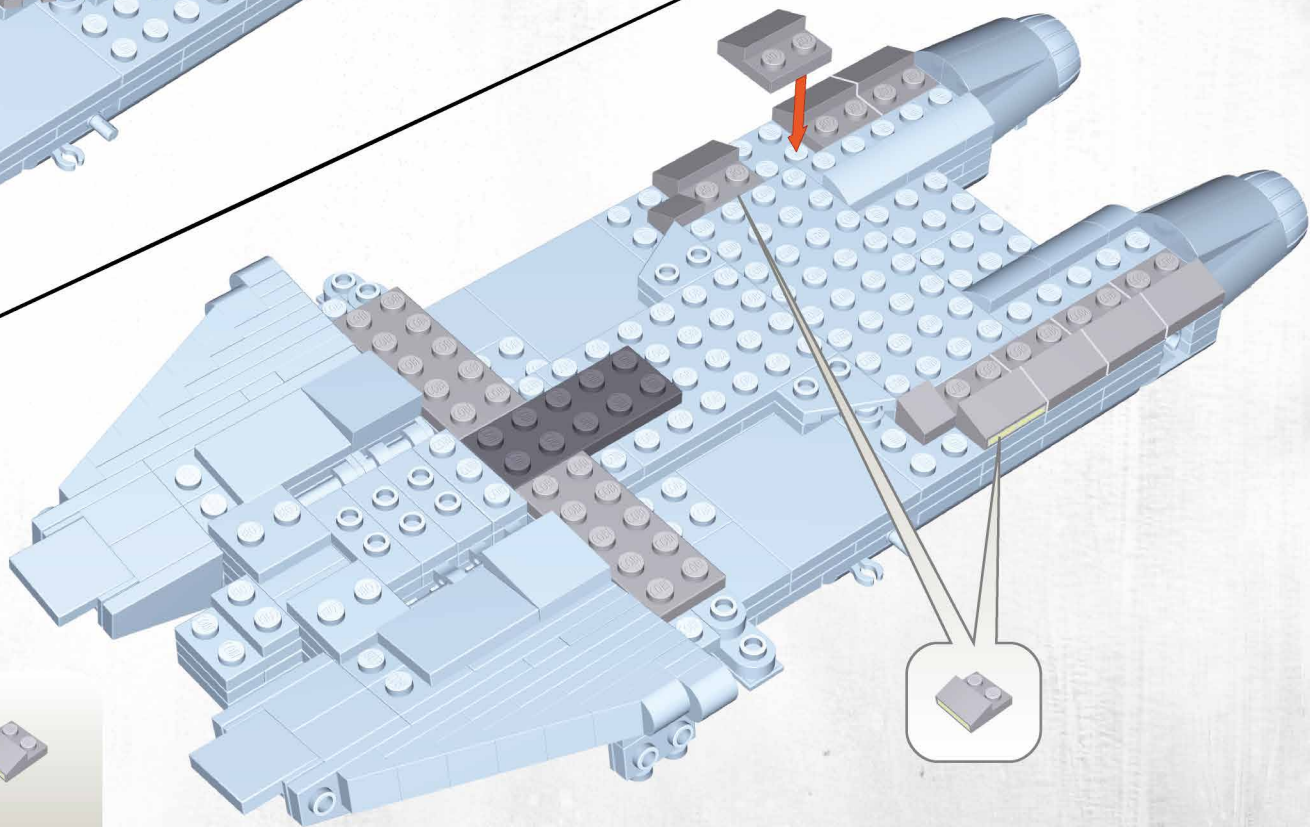

x1	x2	x2	x6	x2

54

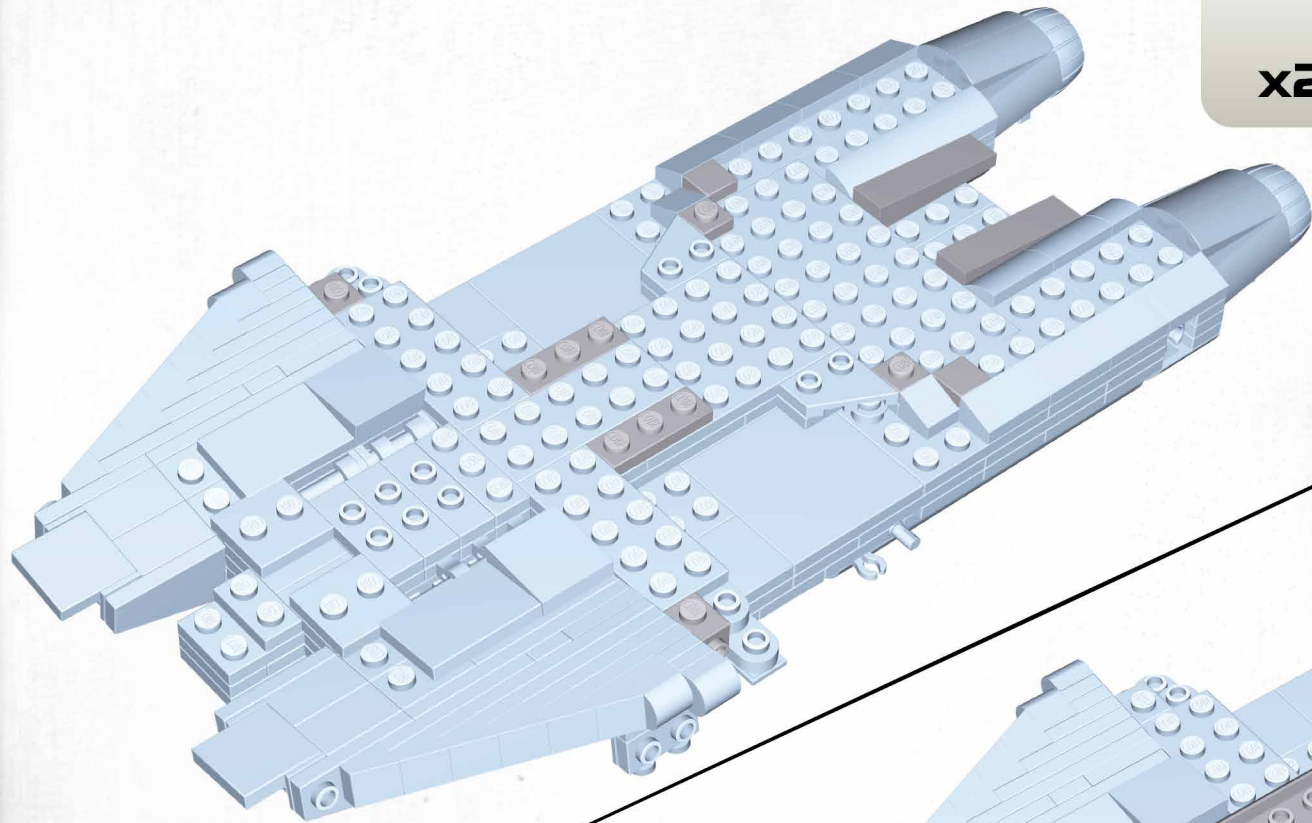

x2	x2	x2	x2	x2

55

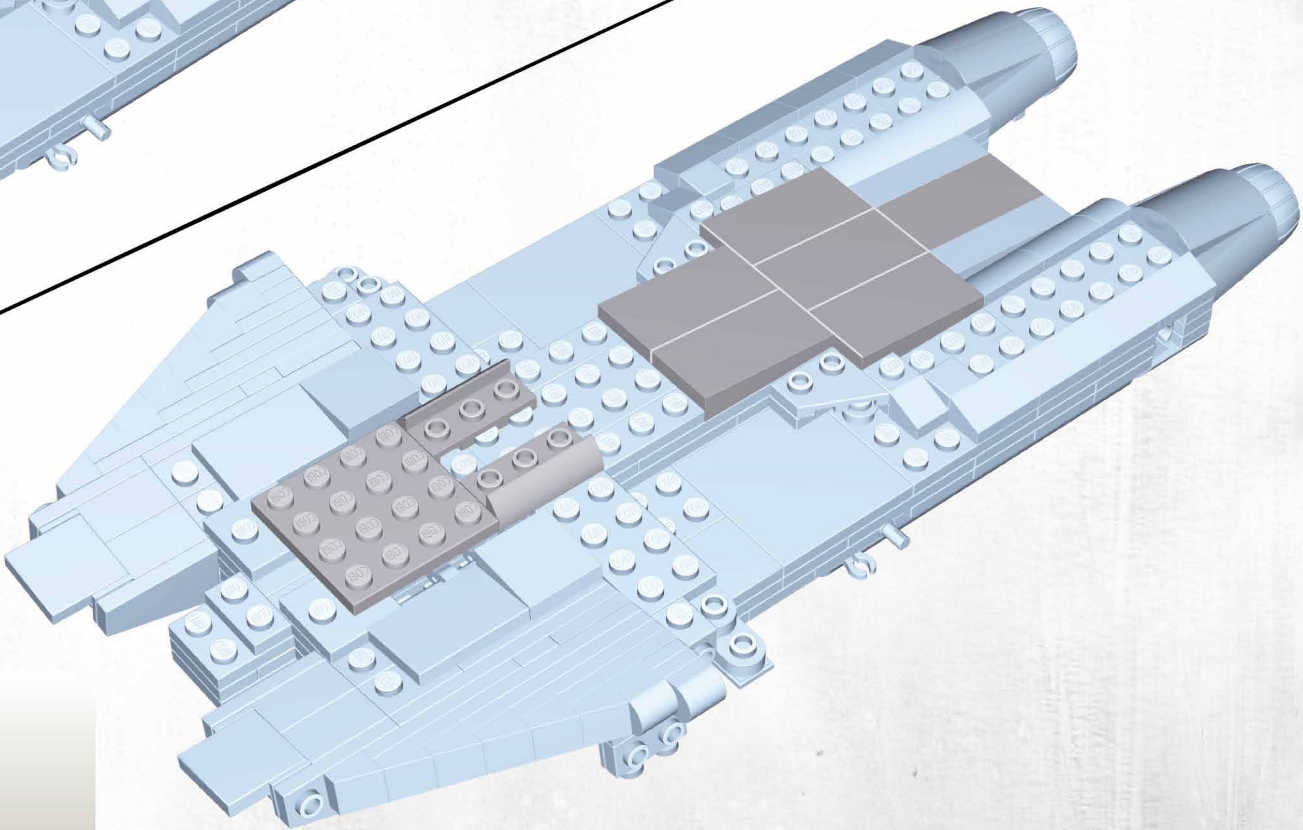

x6	x1	x2

56

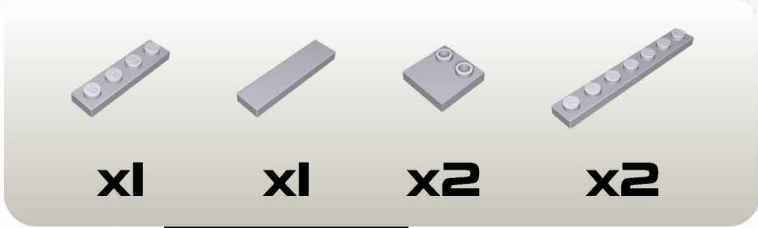
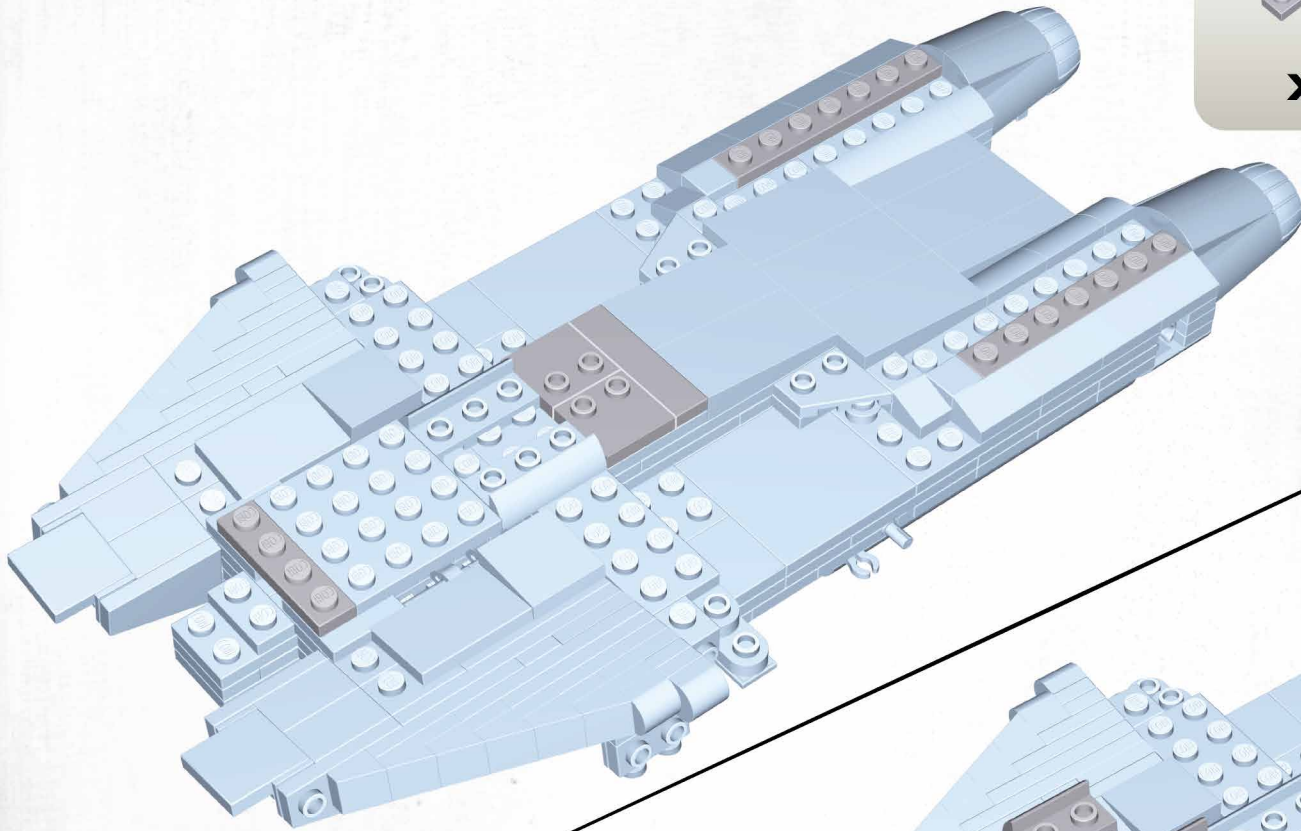

x1

x1

x2

x2

1:1

57

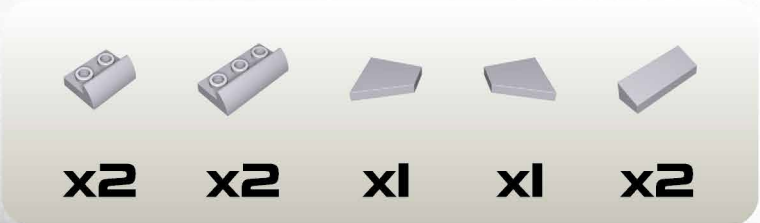
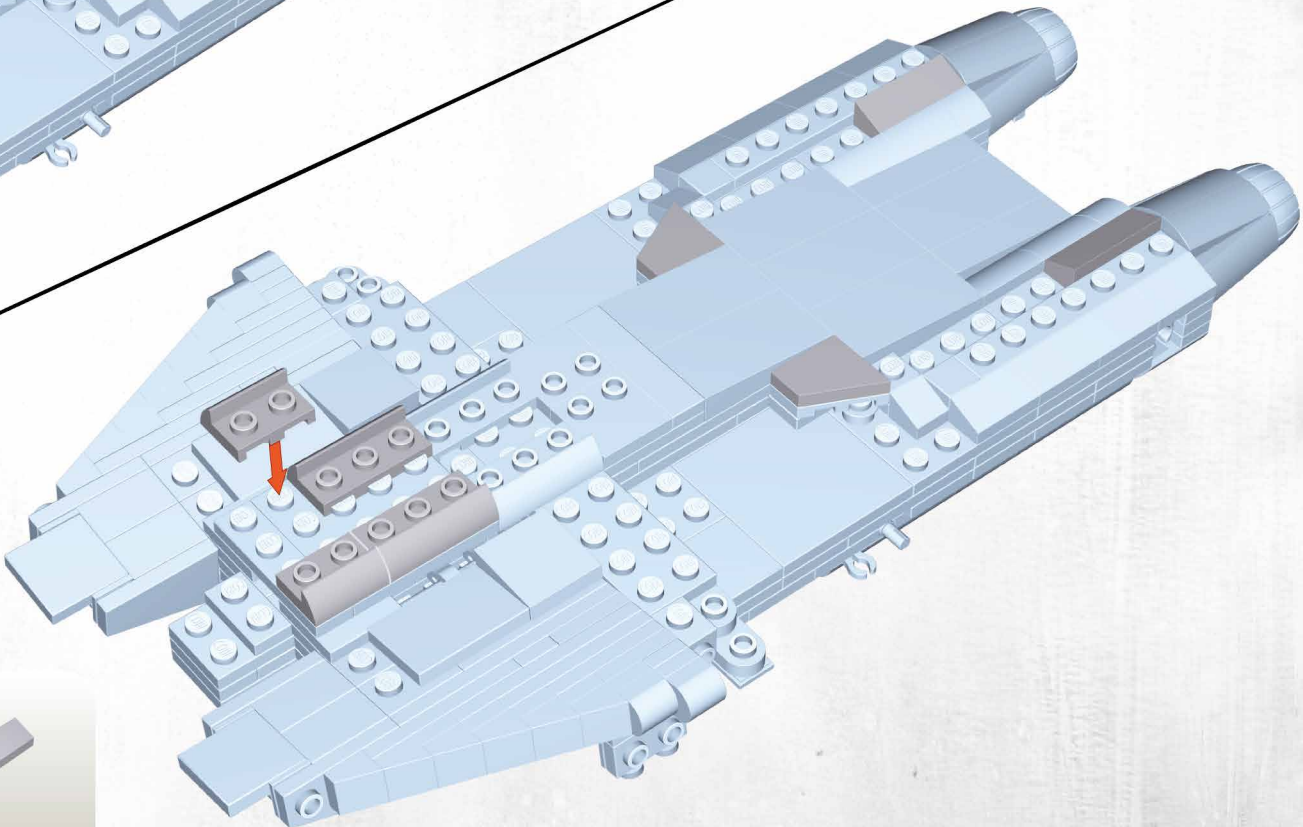

x2

x2



x1

x1

x2

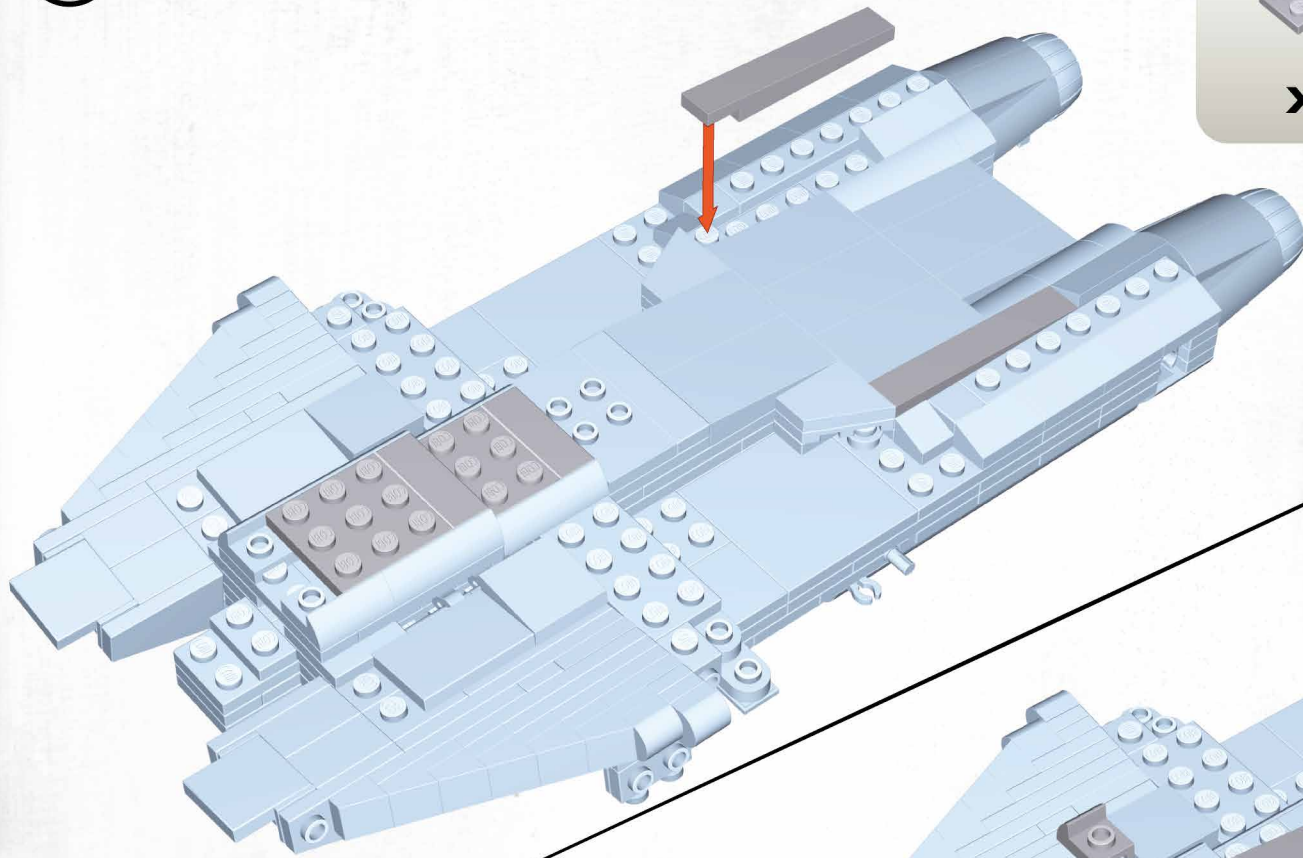

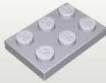
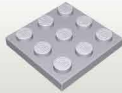

58

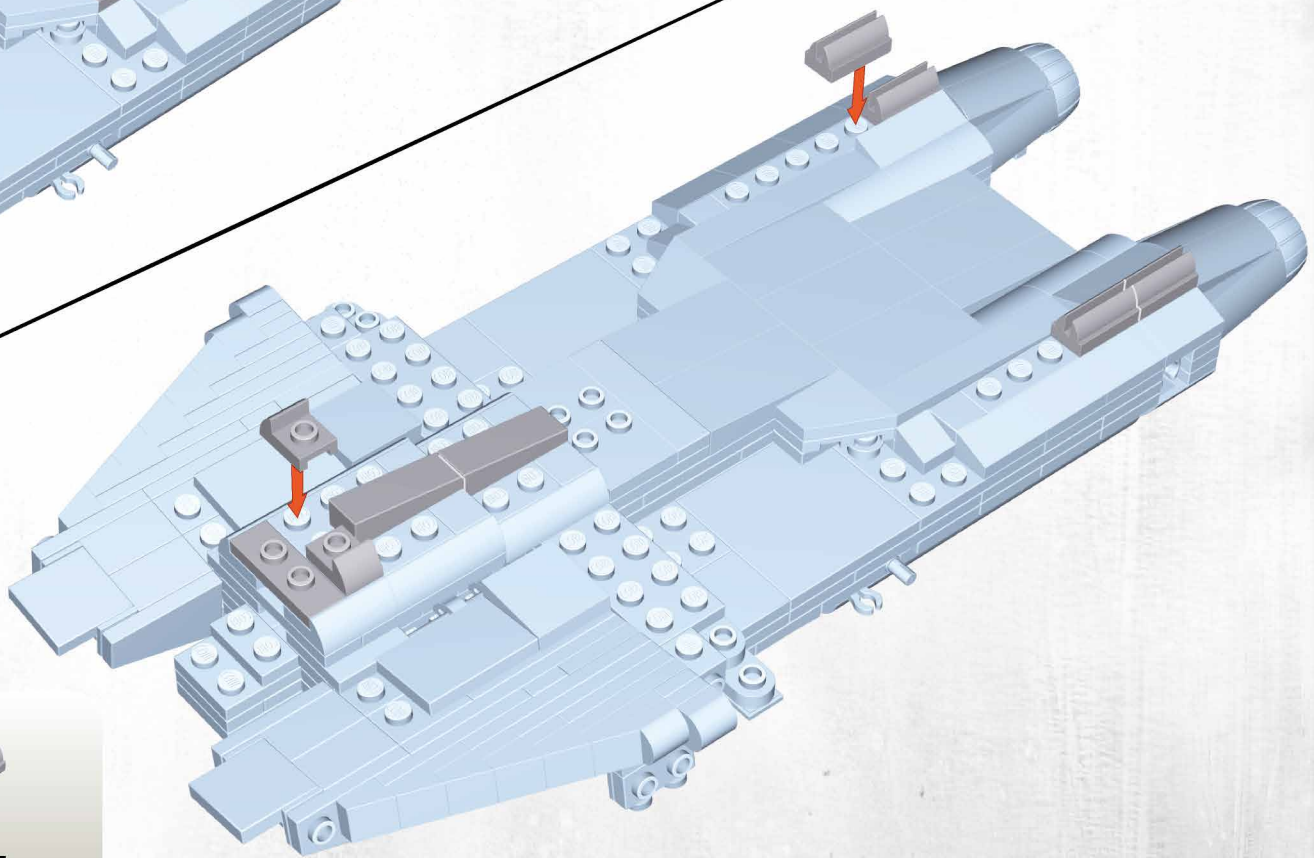

			
x1	x1	x2	x2
1:1			

59



			
x1	x2	x2	x4

60

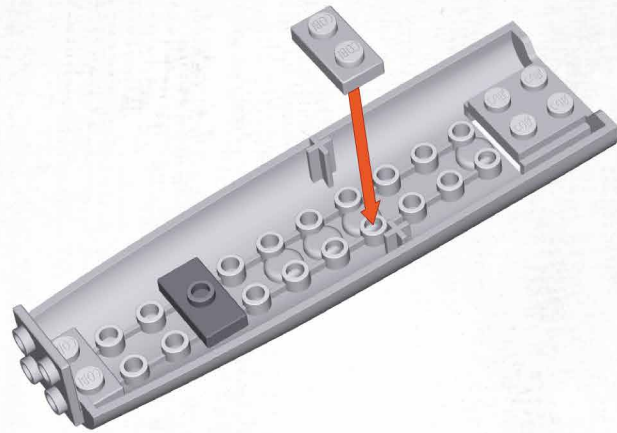

x1



x1



x1



x1

61

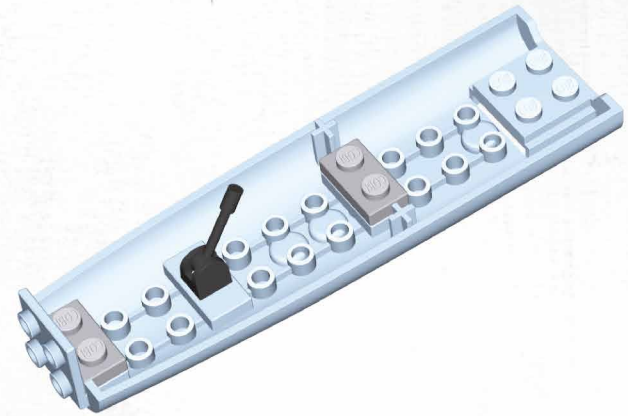

x2



x1



x1

62



x2



x4

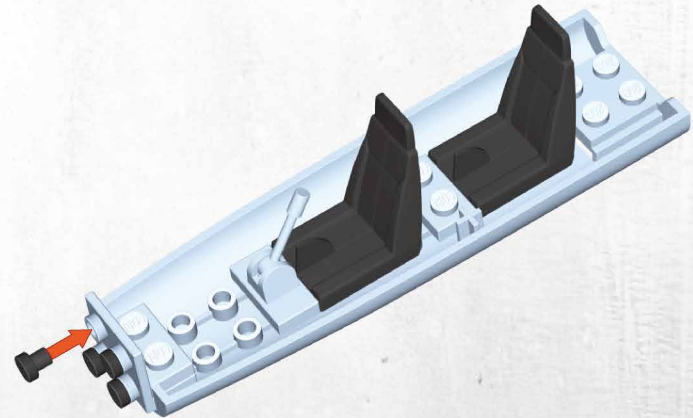

63

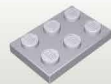
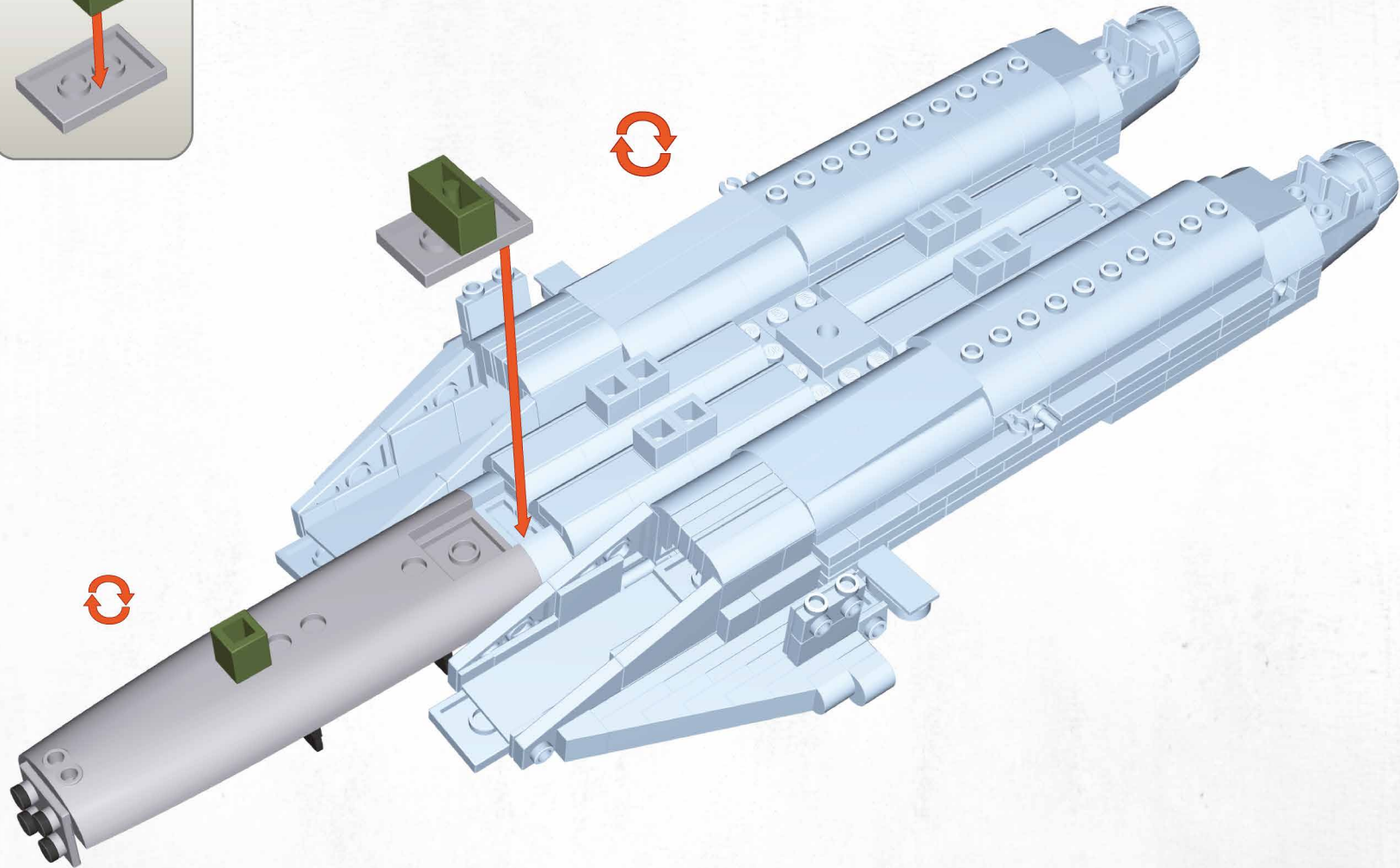
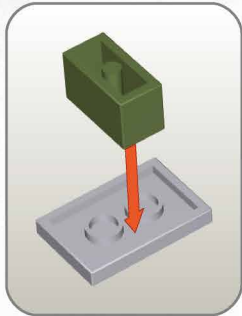

x1



x1



x1

64

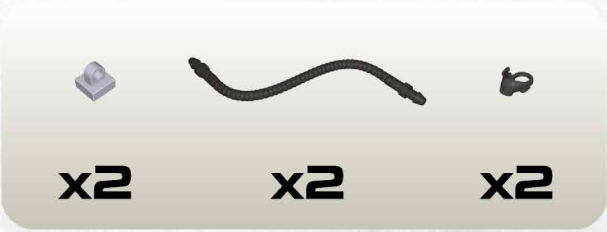
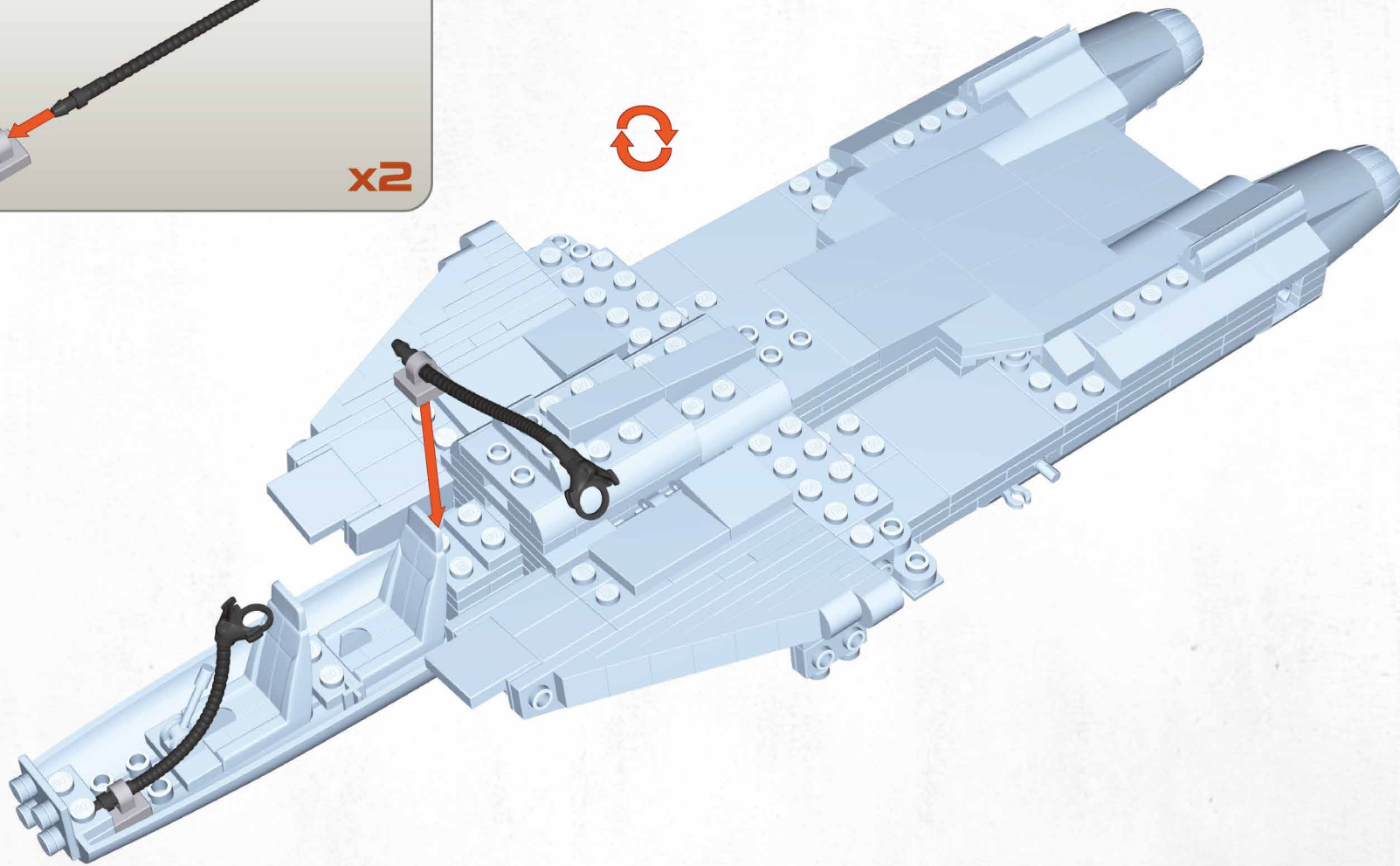
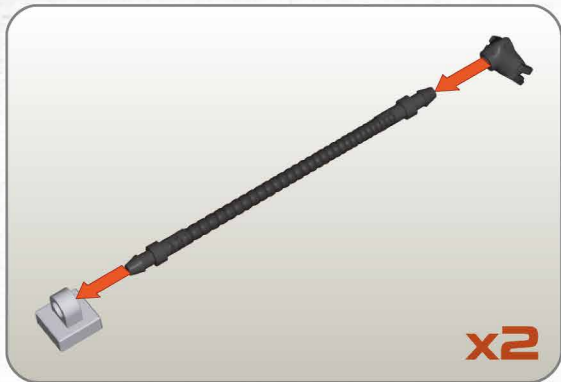

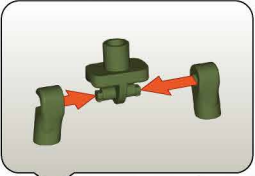

x2

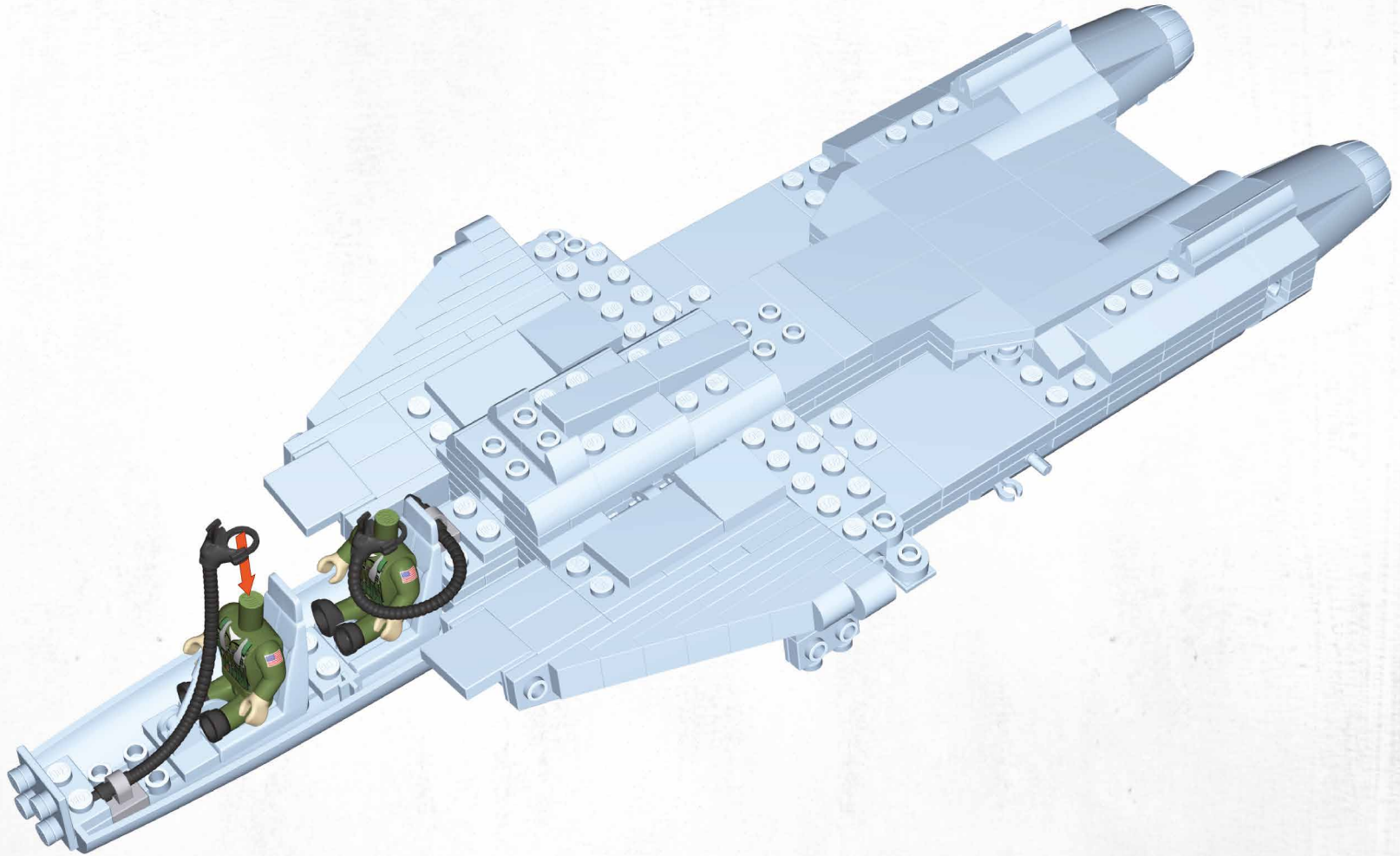

x2



x2



x2



x4



x2

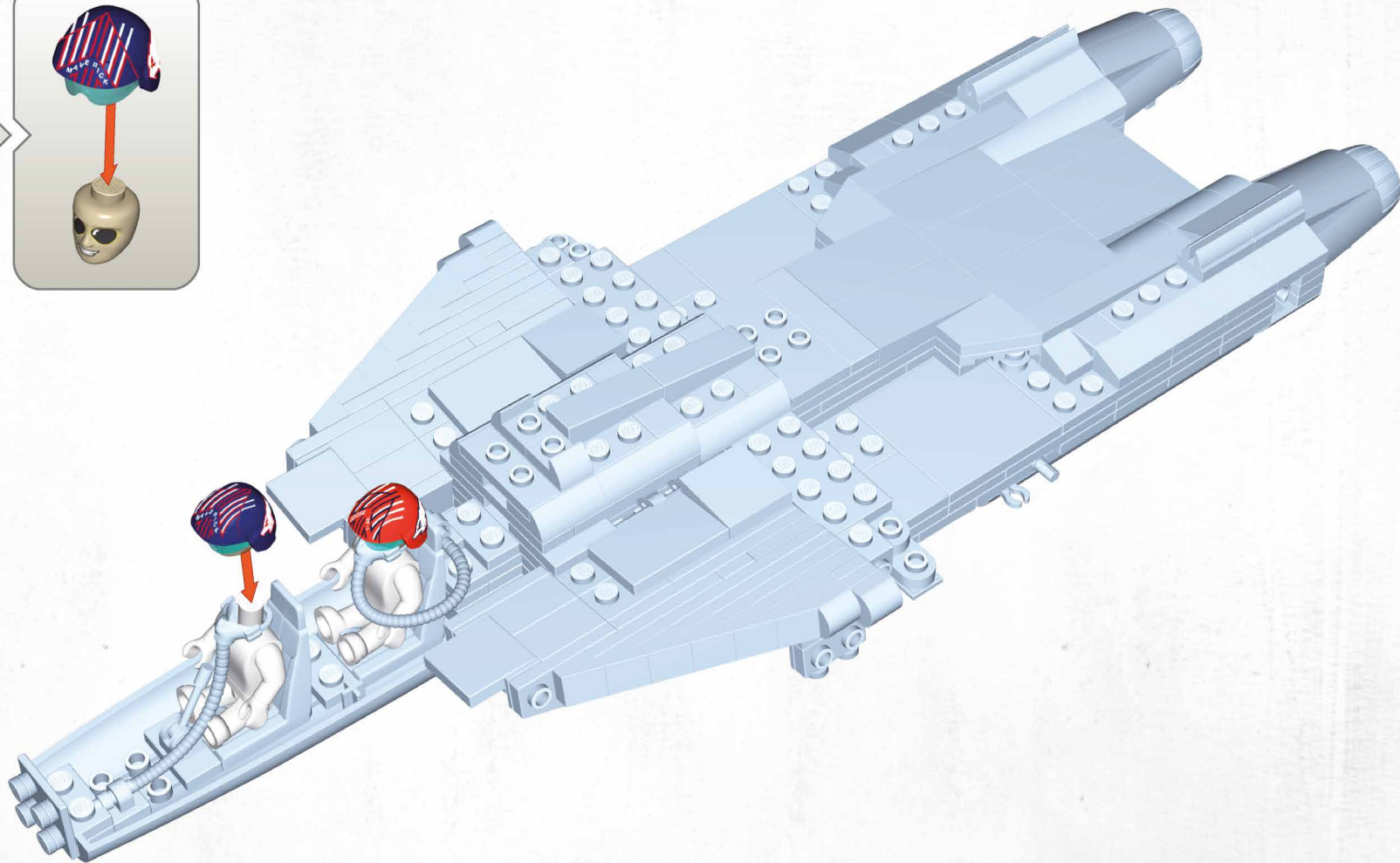
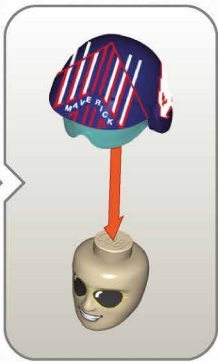
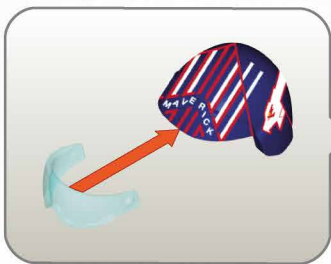

x2



x1



x1



x1



x1

67

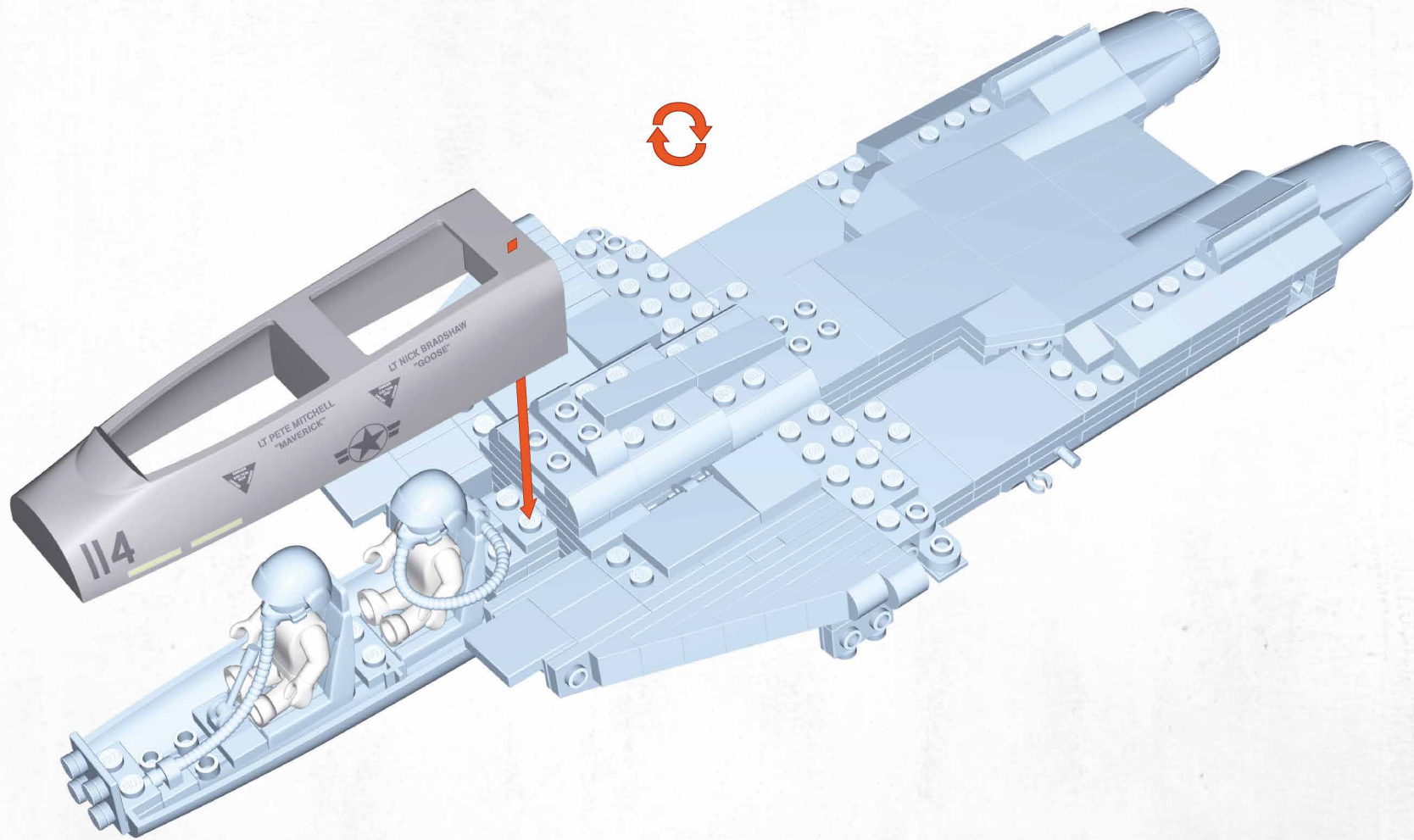

x1

68

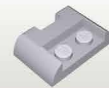
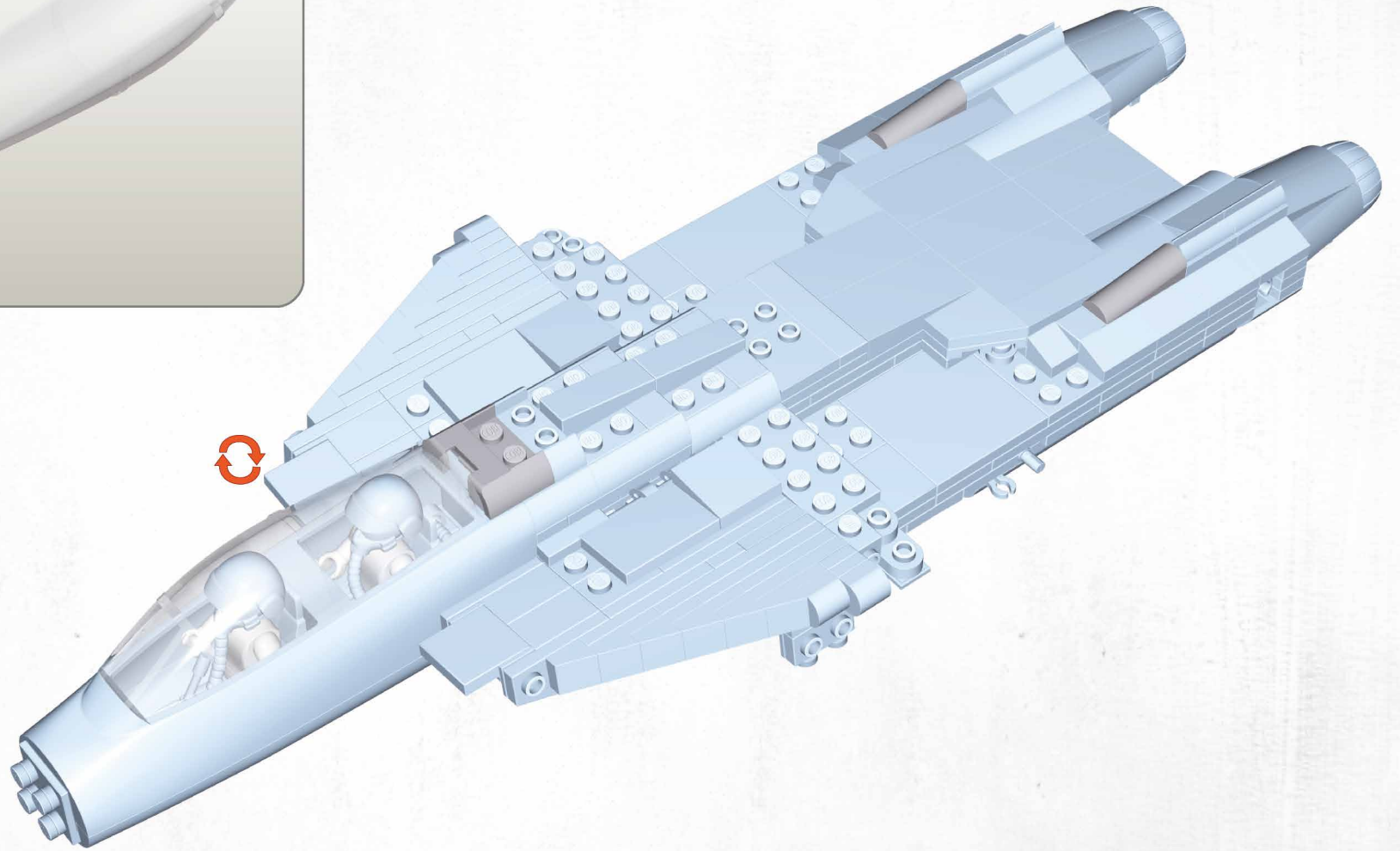
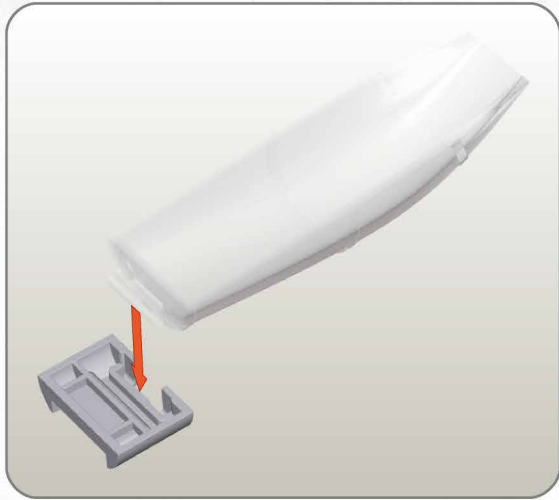

x1



x1



x2

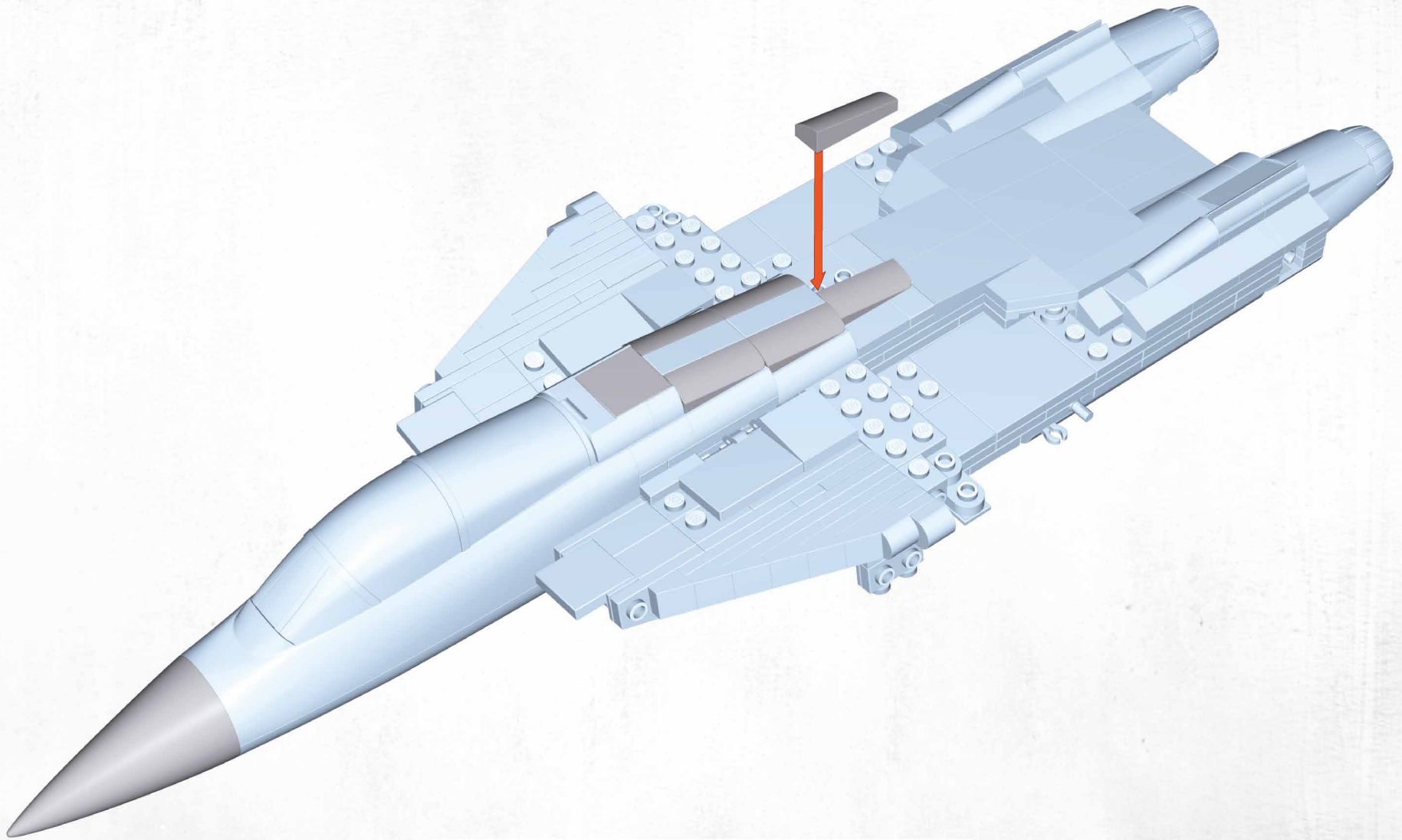

x1

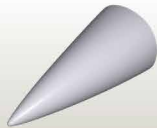

x1



x3



x3

70

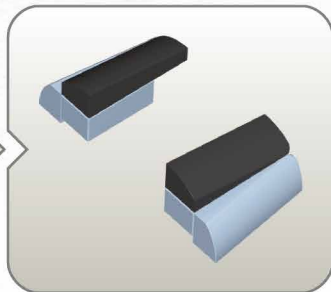
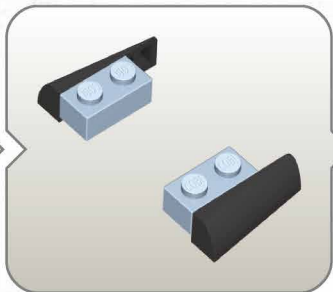

x2

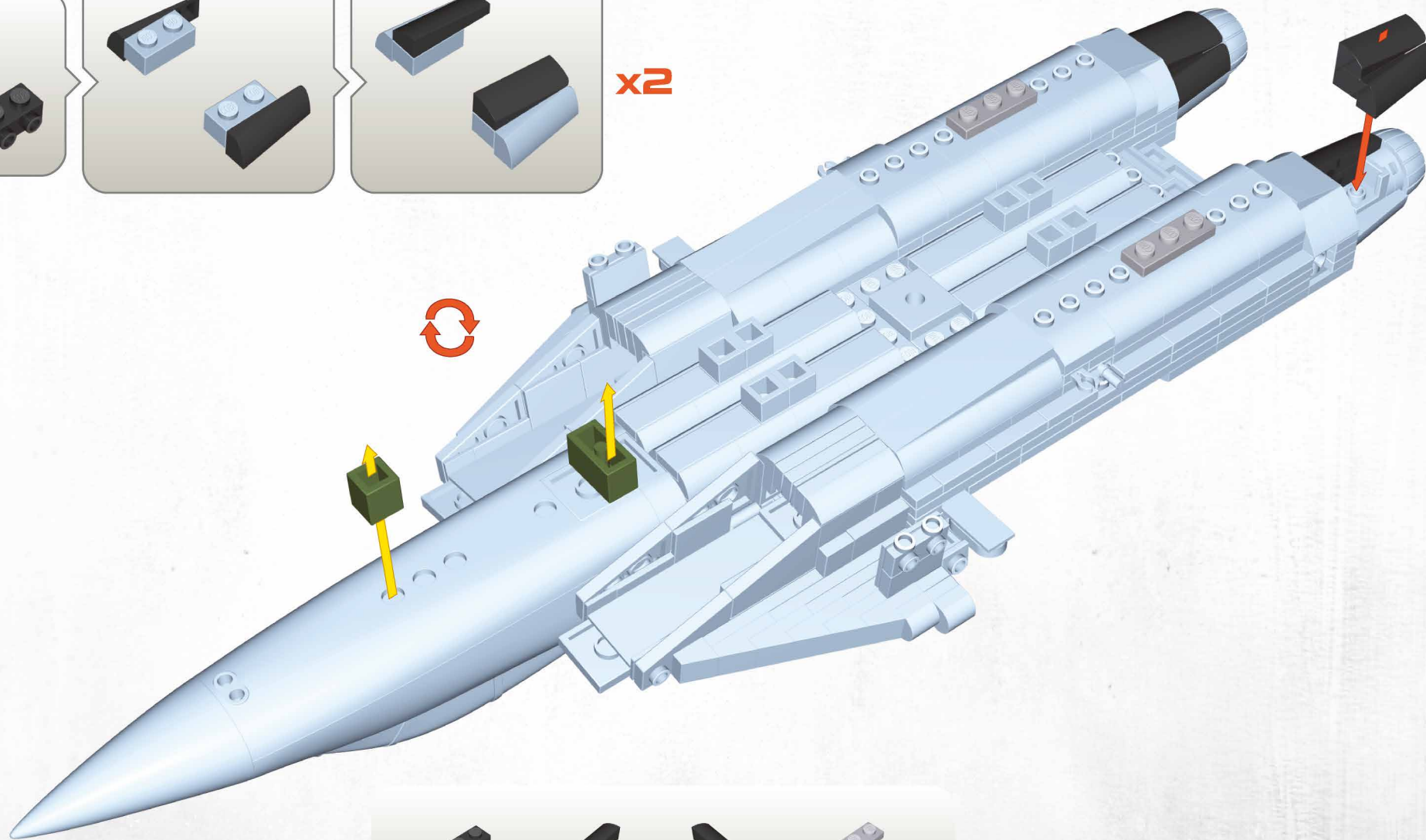

x4



x4



x4



x2

71

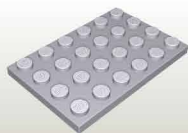
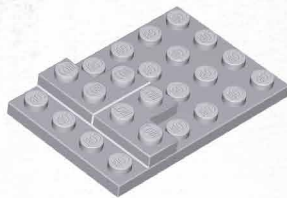

x1



x2

72

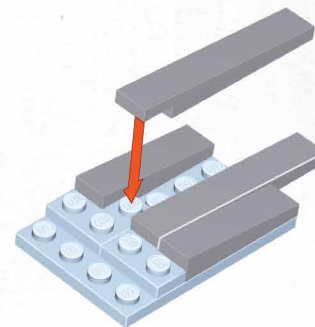

x2

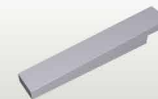

x2

73

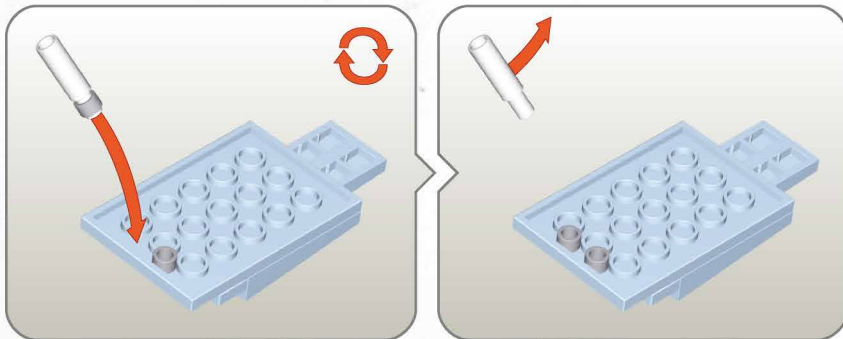

x2

74

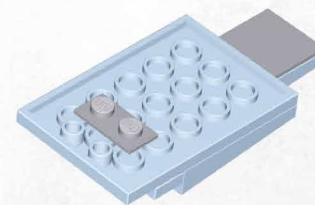

x1



x1



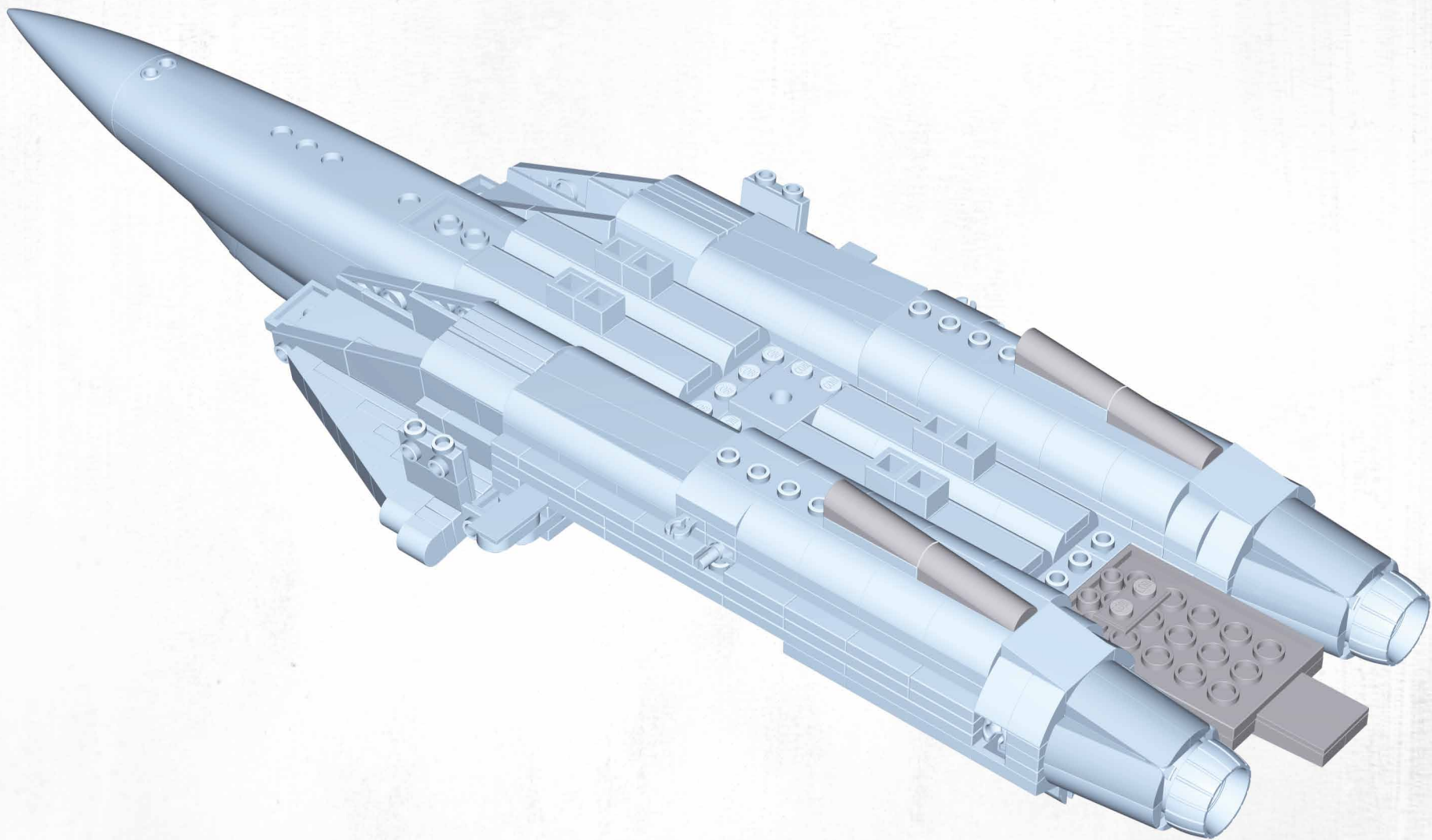

75

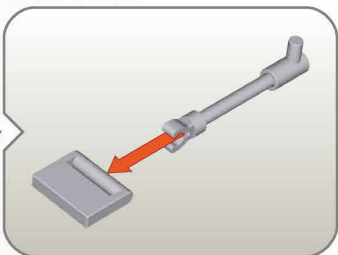
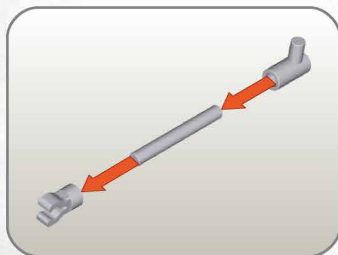
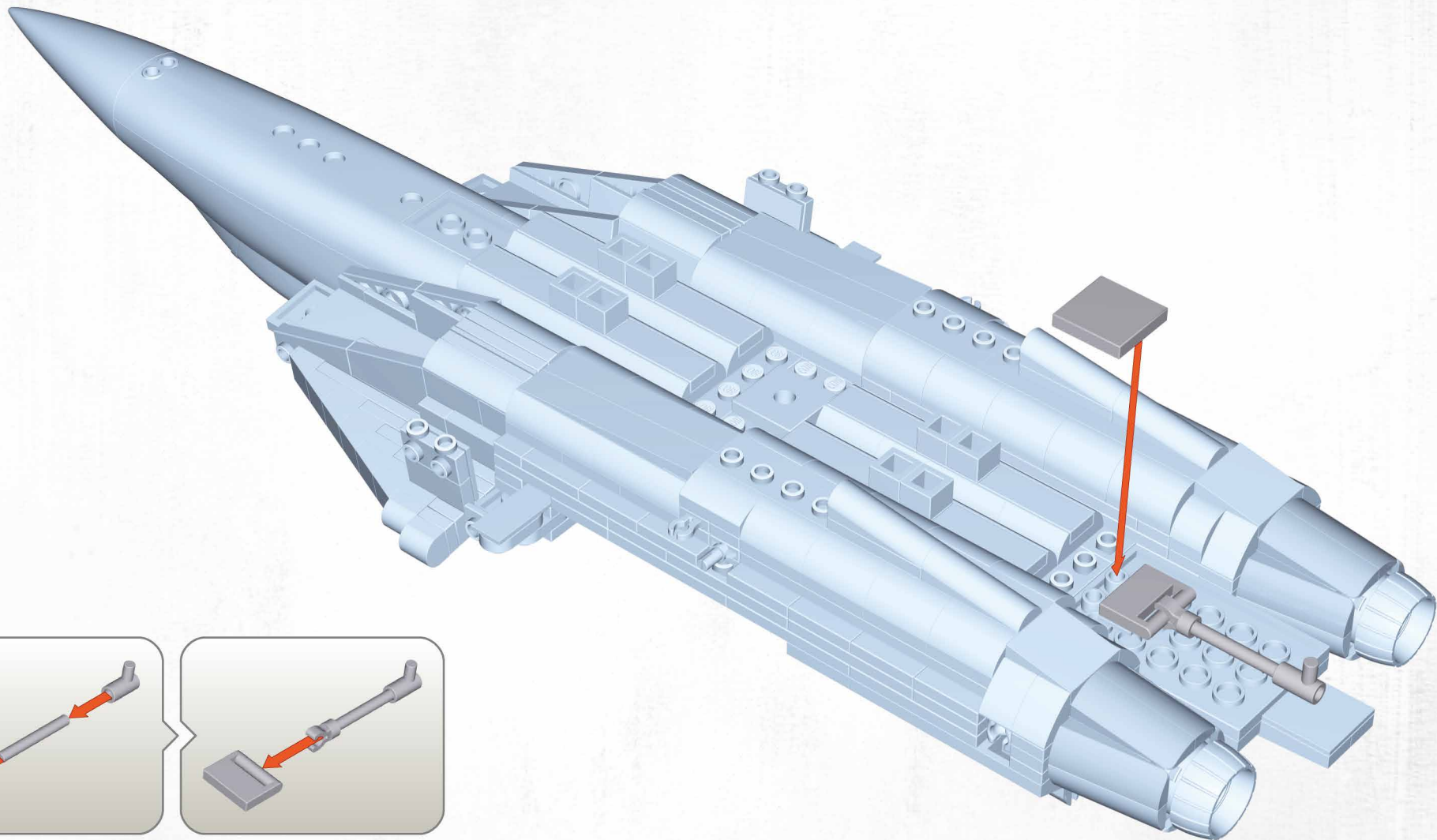

x4

76



-  **x1**
-  **x1**
-  **x1**
-  **x1**
-  **x1**

77

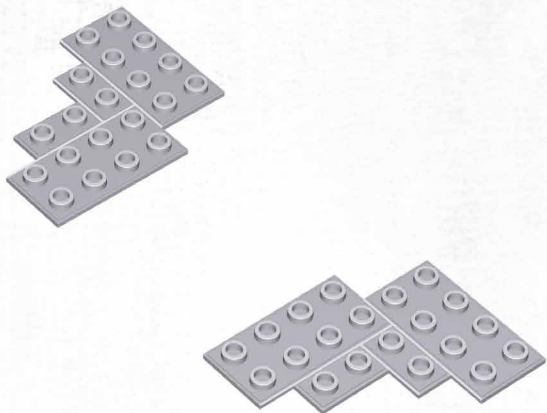

x4



x4

78

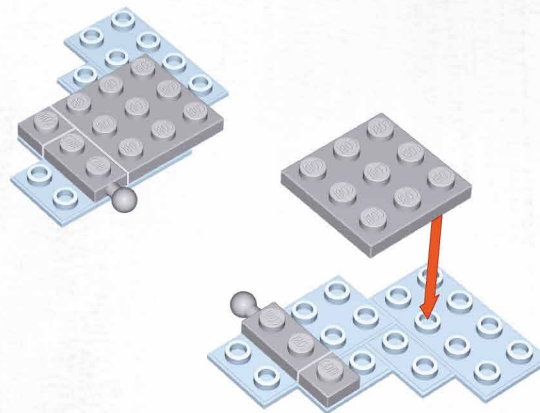

x2



x2

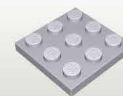

x2

79



x2



x2

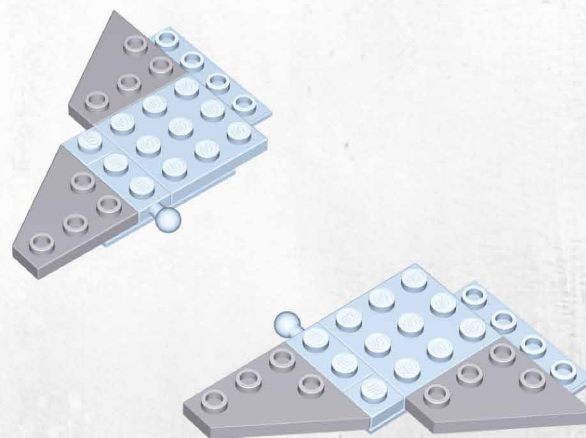

80

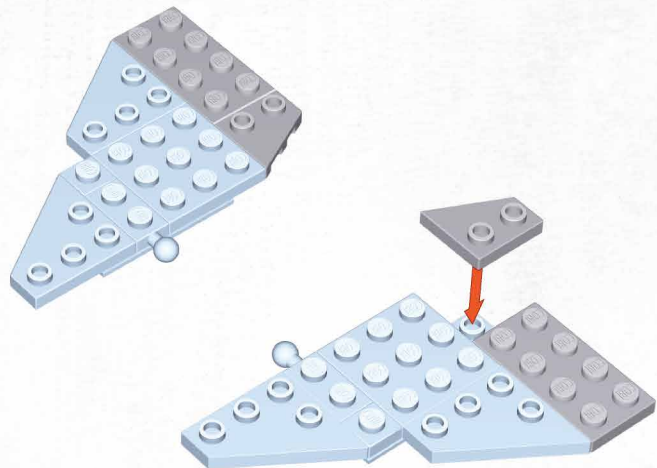

x2



x1



x1

81

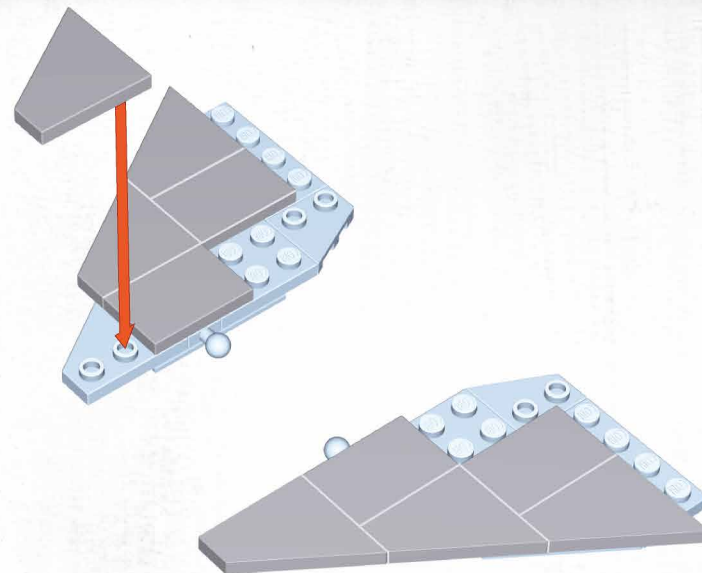

x4



x3

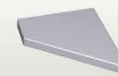

x3

82



x1

x1

x1

x1

x2

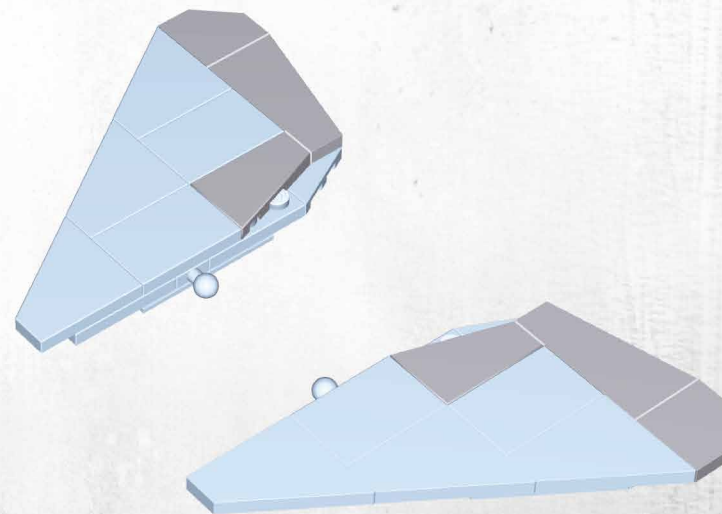

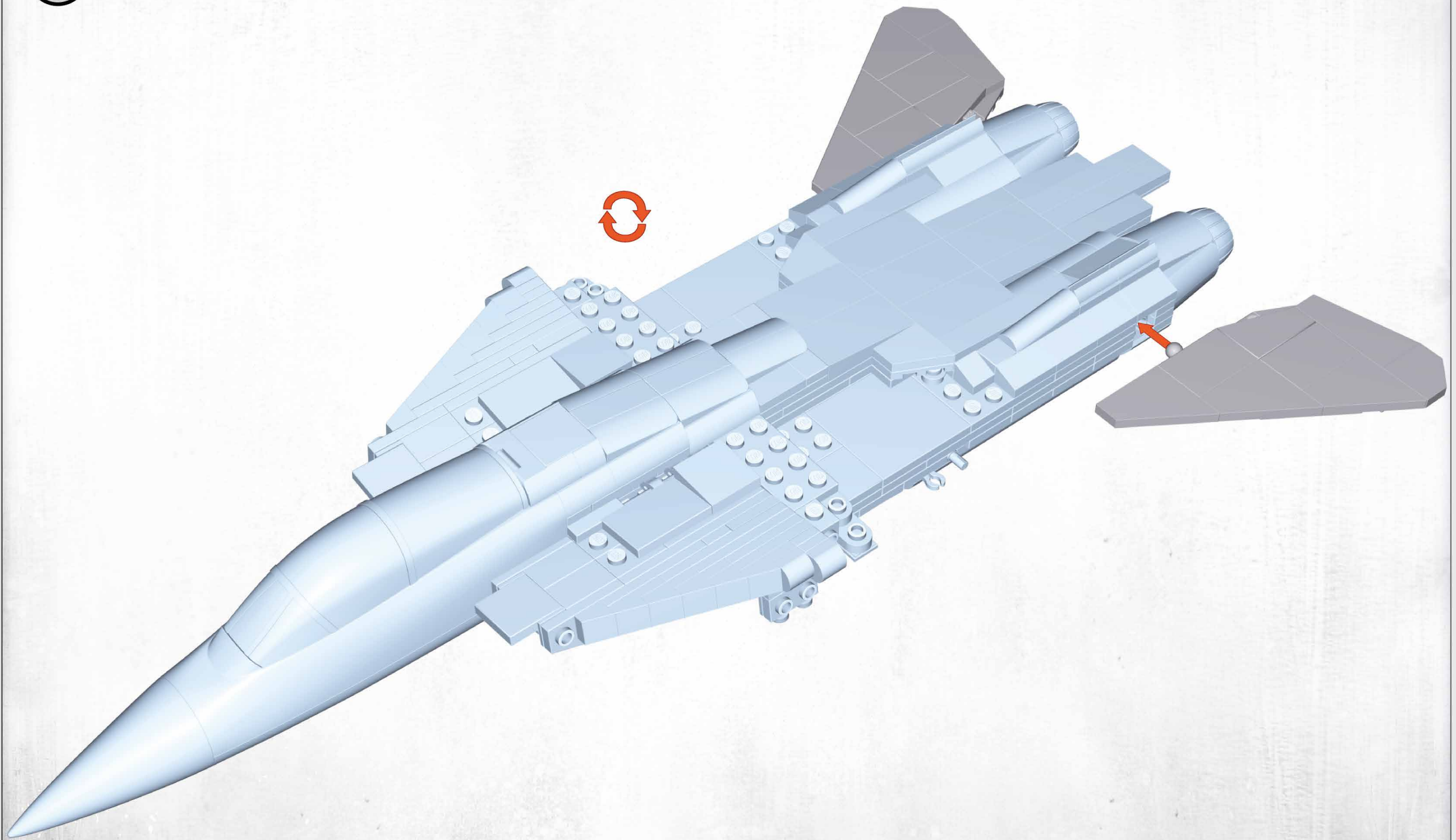

84

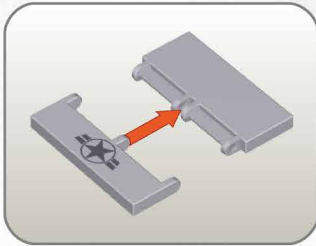
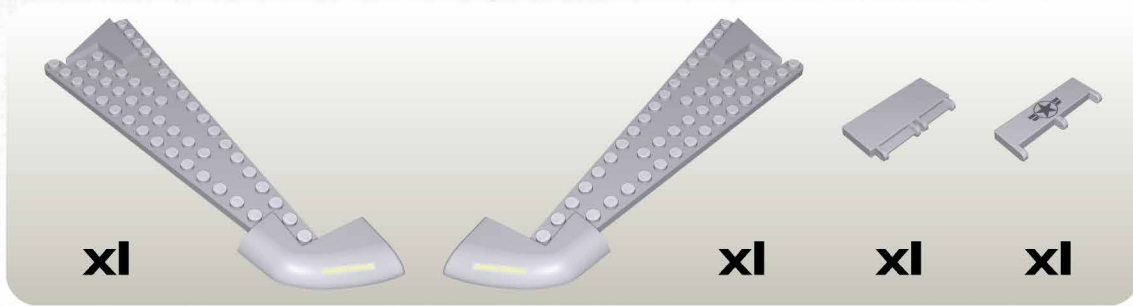

85

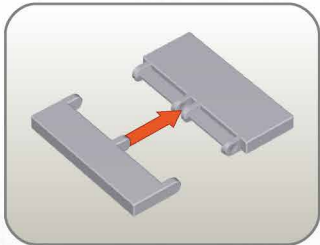

x4

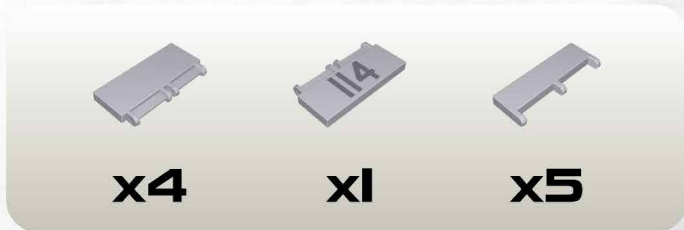
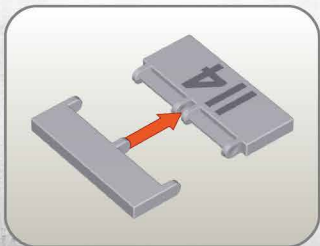
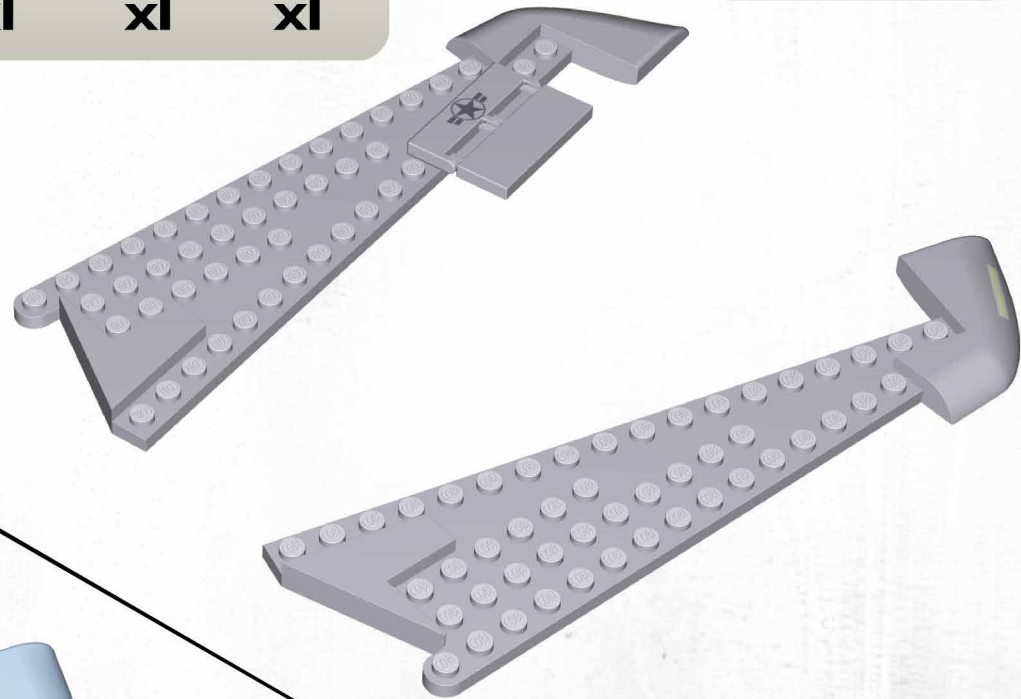

86

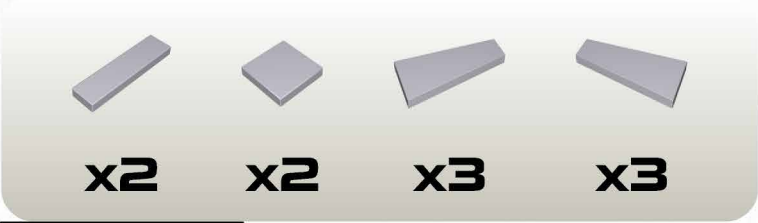

1:1

87

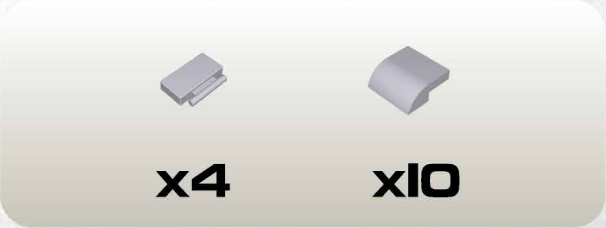
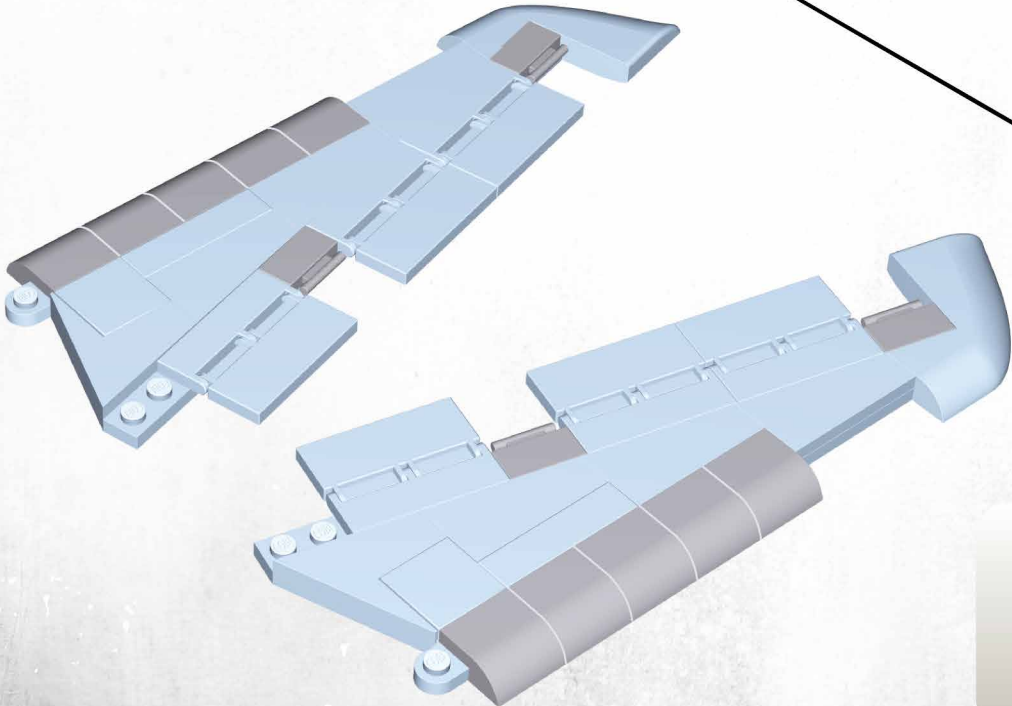
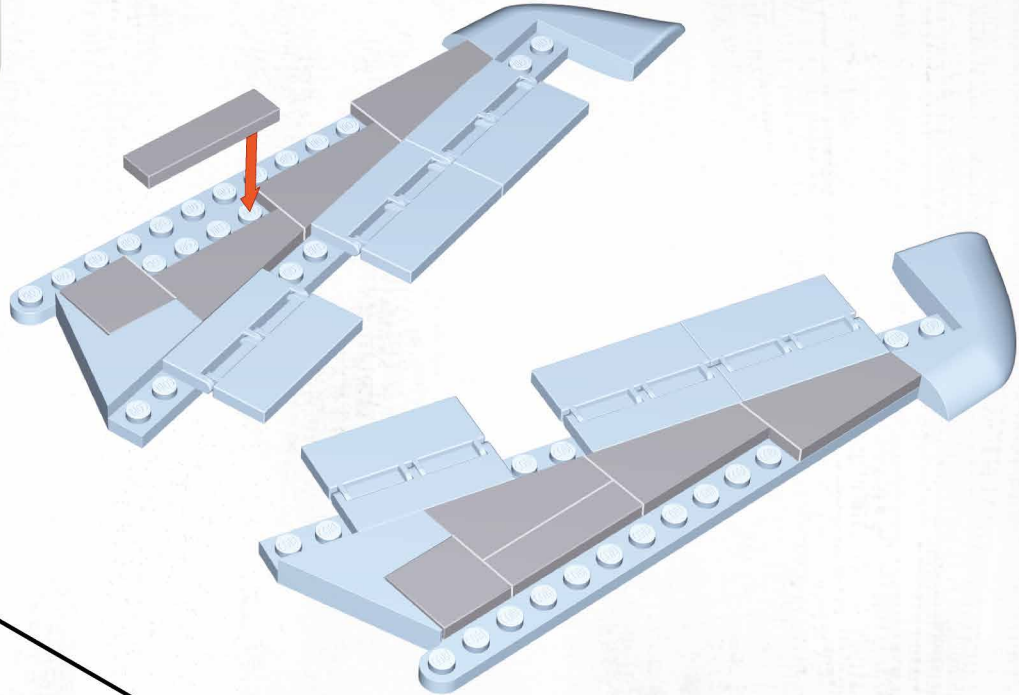

88



x4

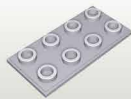

x2



x2

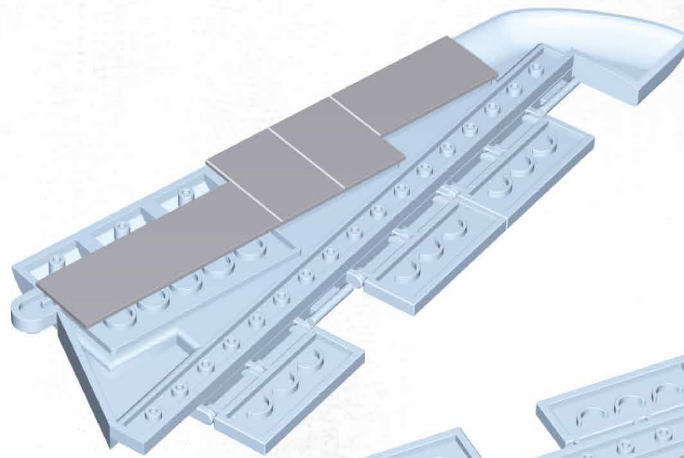

89

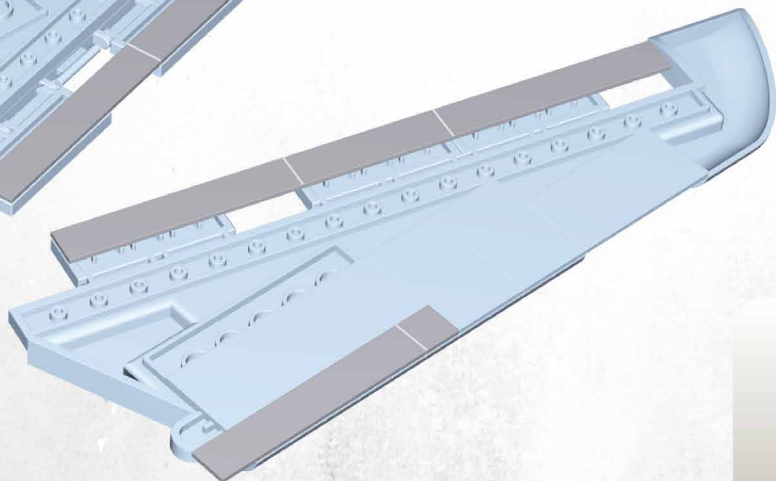
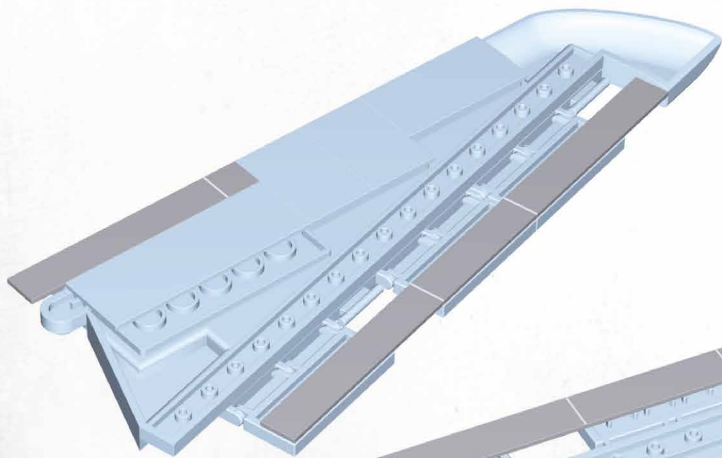

x6



x2



x2

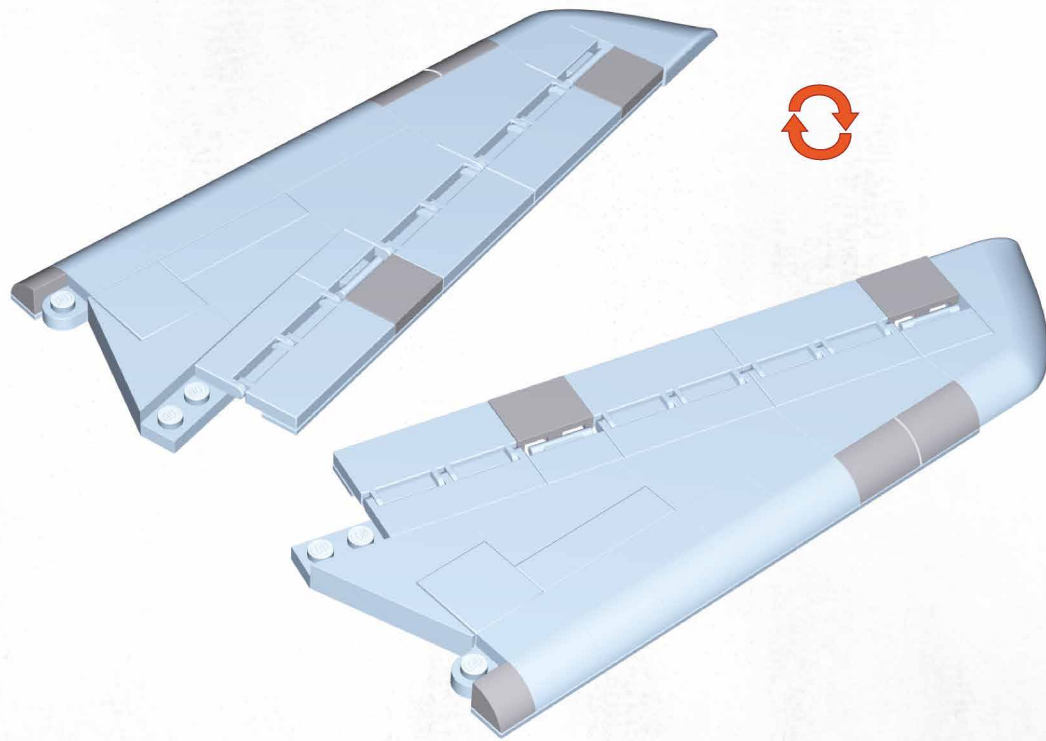

x4



x2



x4

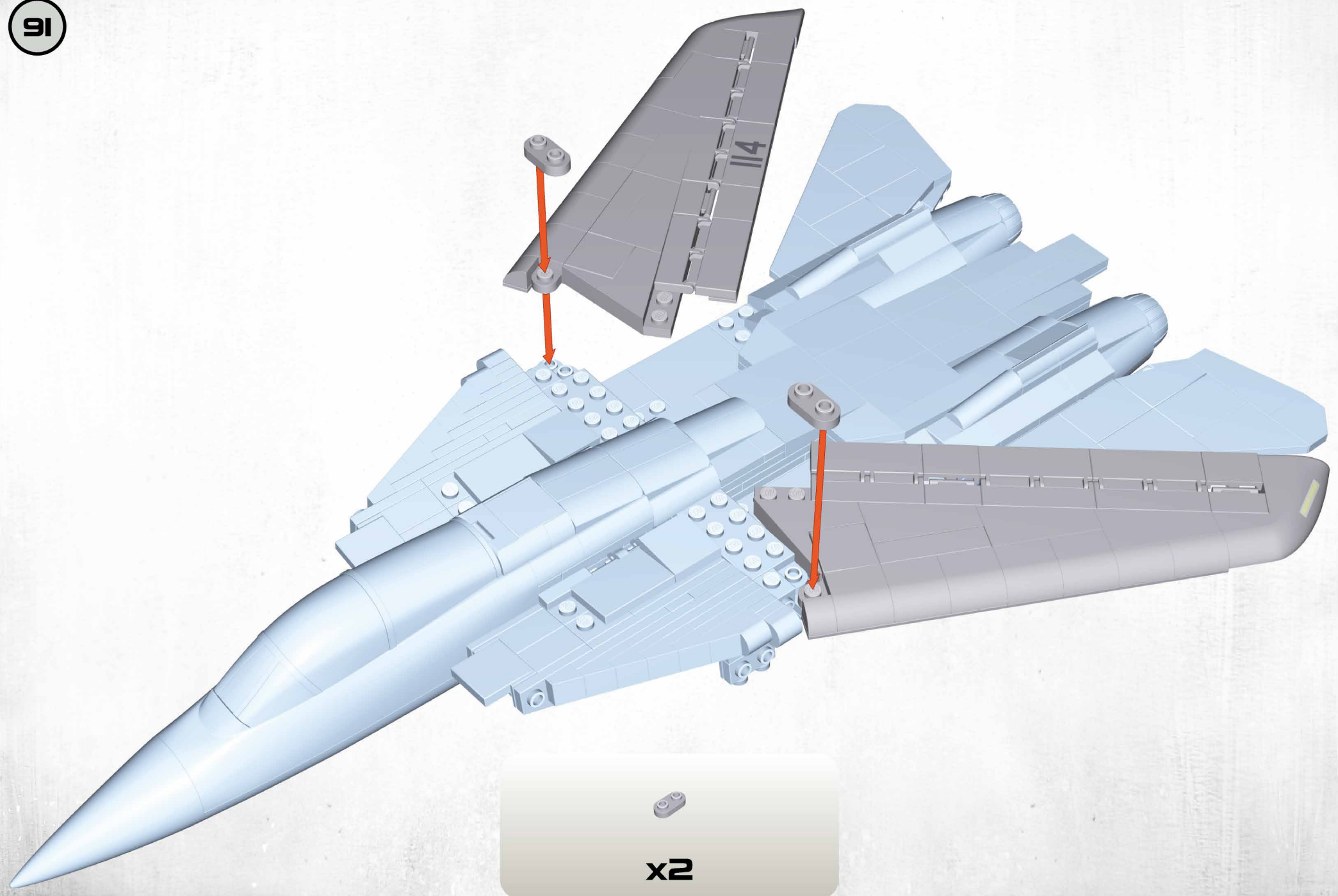

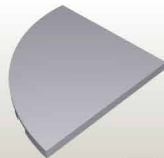
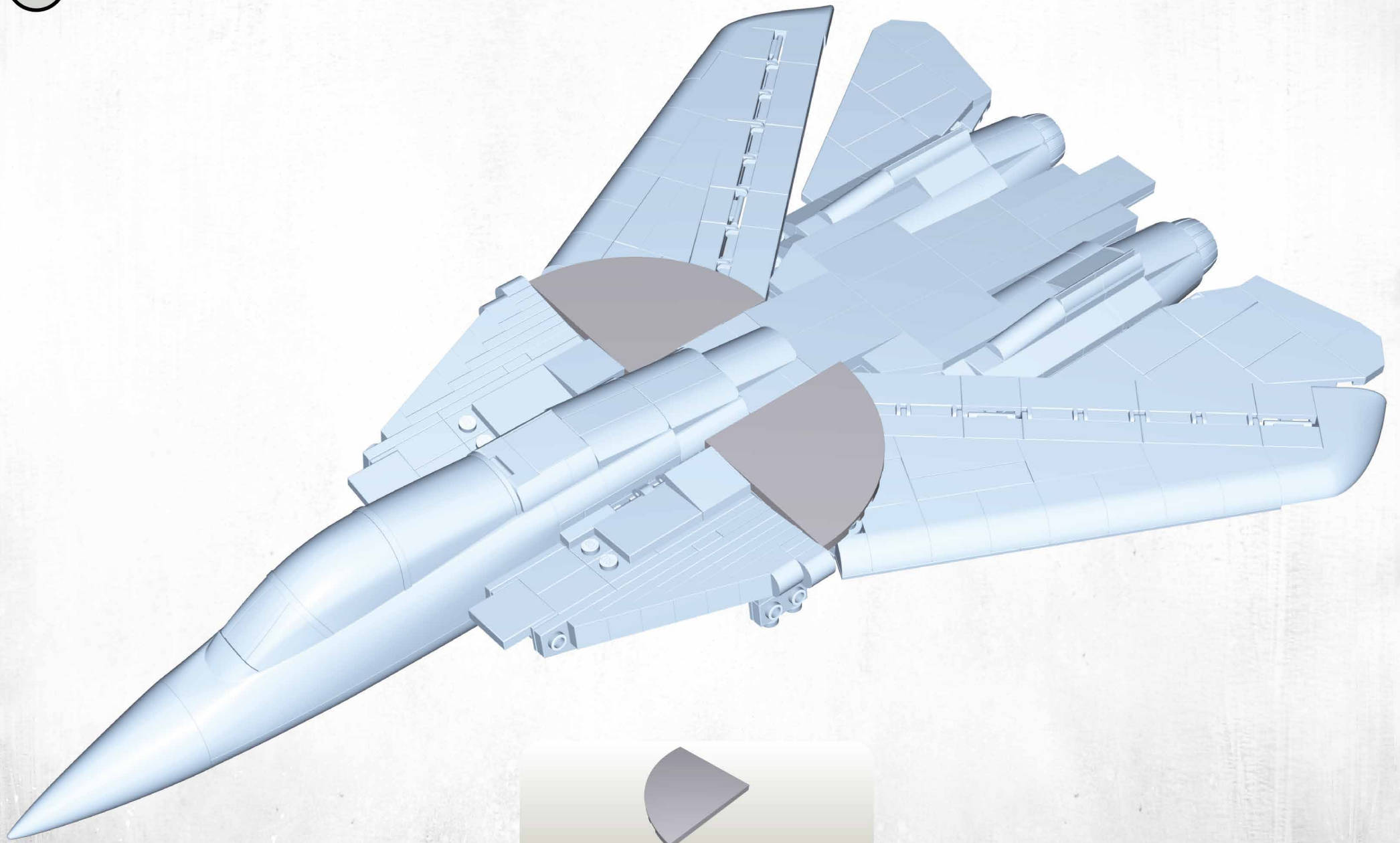

x2

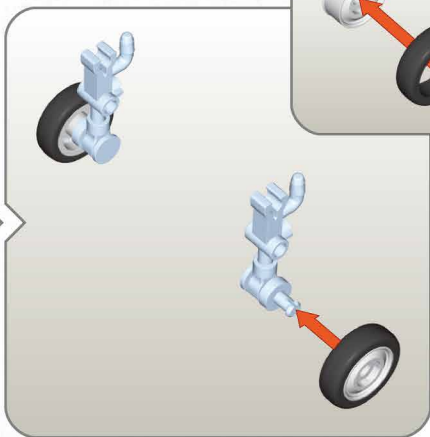
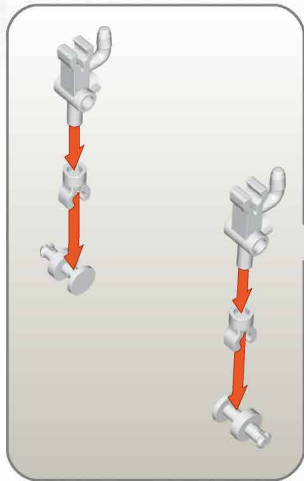

x2

93



x2

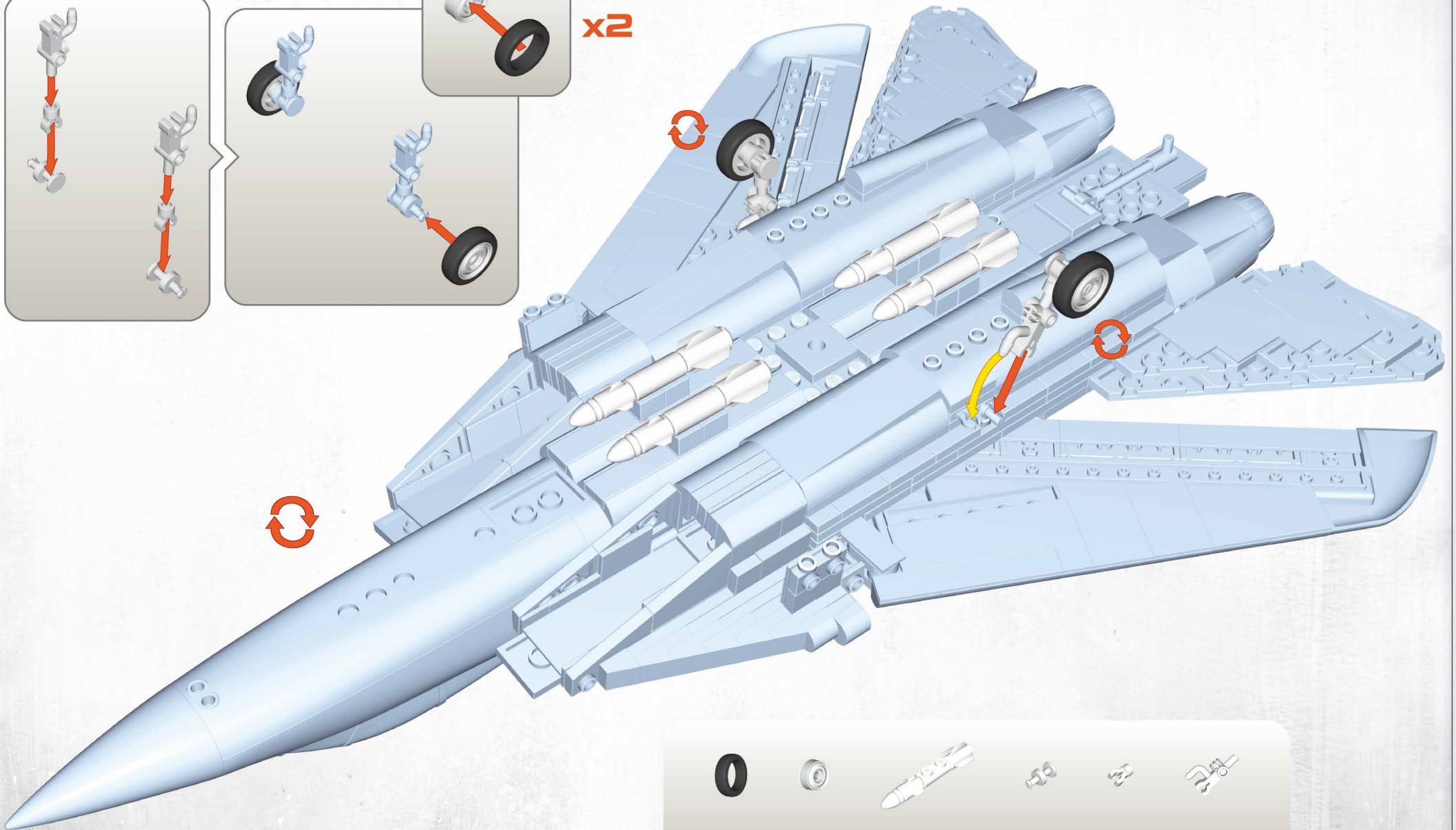

x2



x2



x4



x2



x2



x2

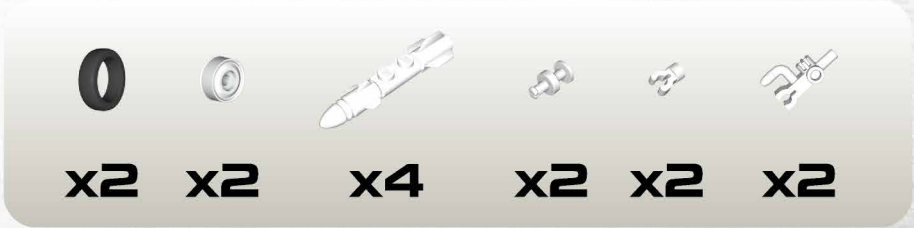

94

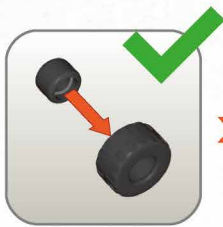

x2

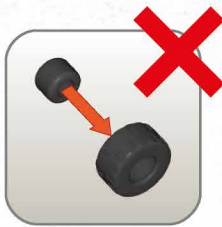

x2



x2

95

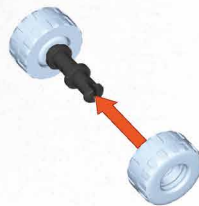

x1

96

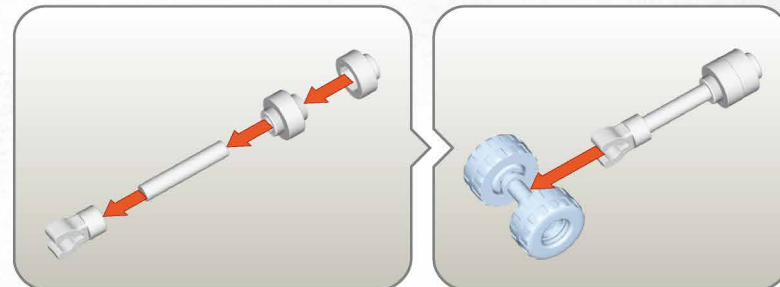

x1



x1



x1



x1

97

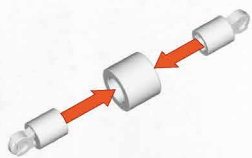

x2



x1

98

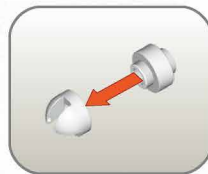
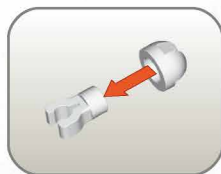

x2



x1







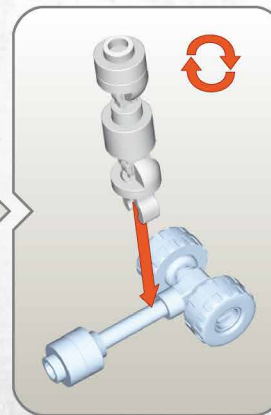
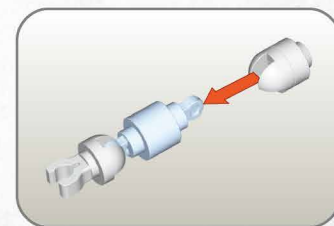

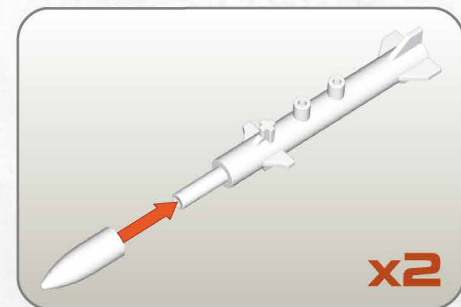
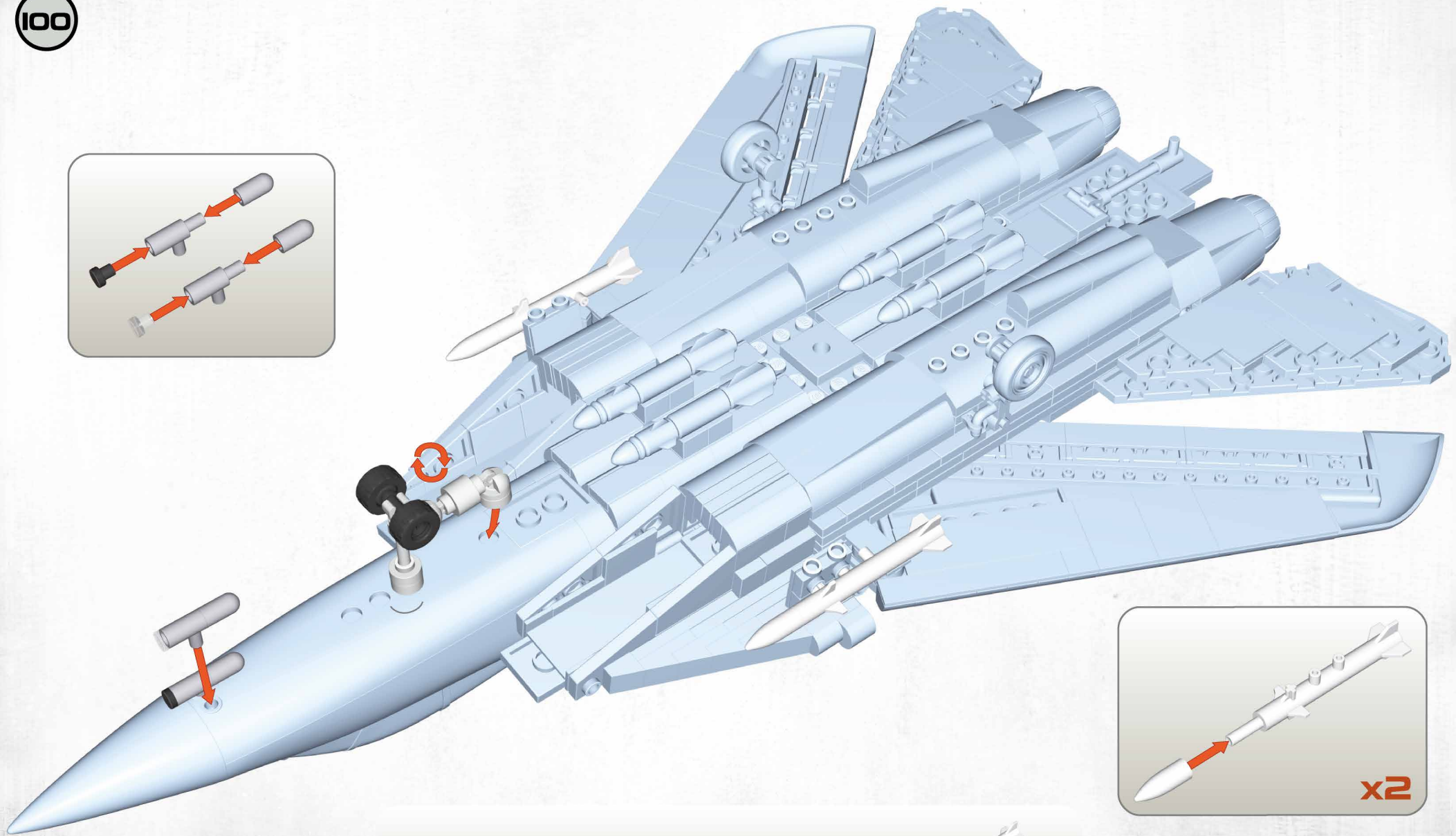
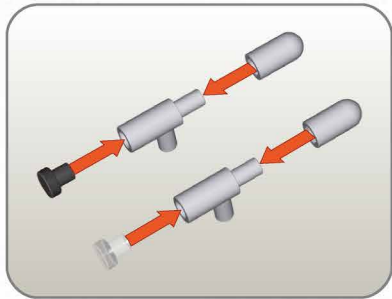

x1

99



100



-  x2
-  x2
-  x1
-  x1
-  x2
-  x2
-  x2

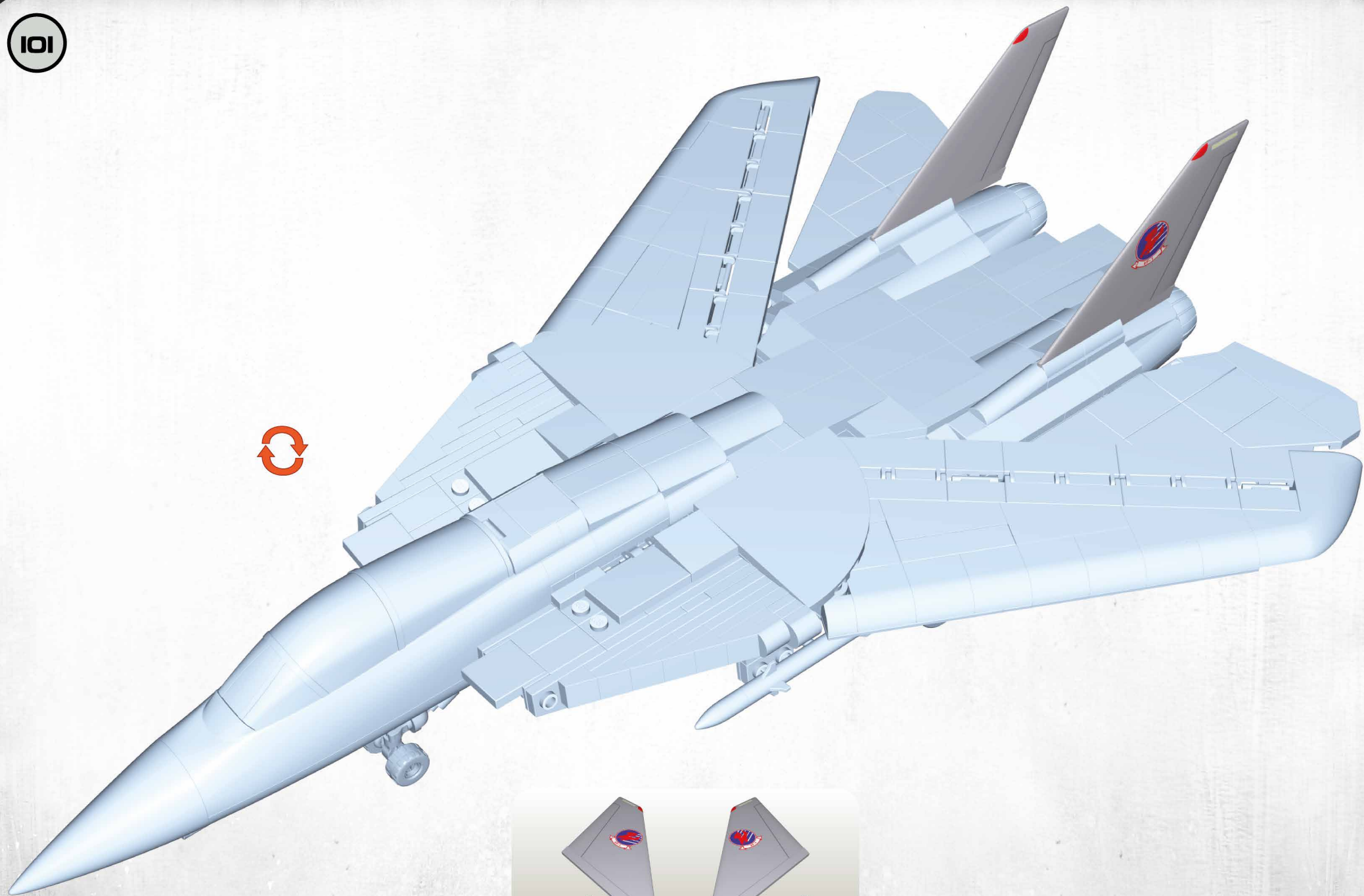

x1



x1

102

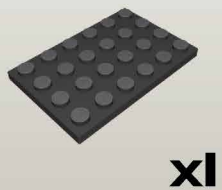
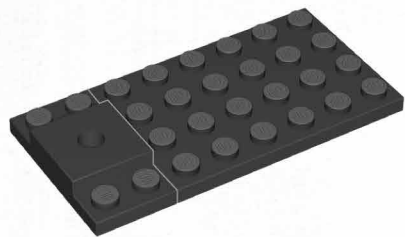

103

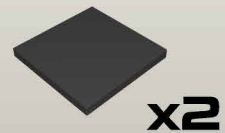
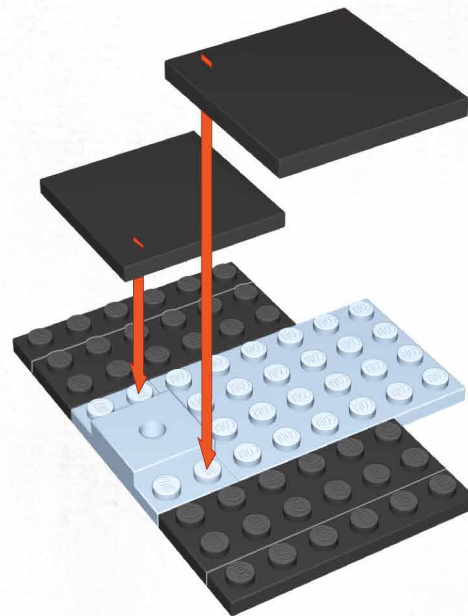

104

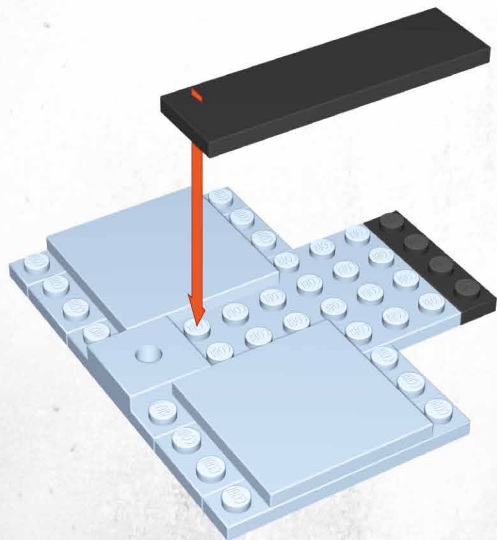

x1



x1

105

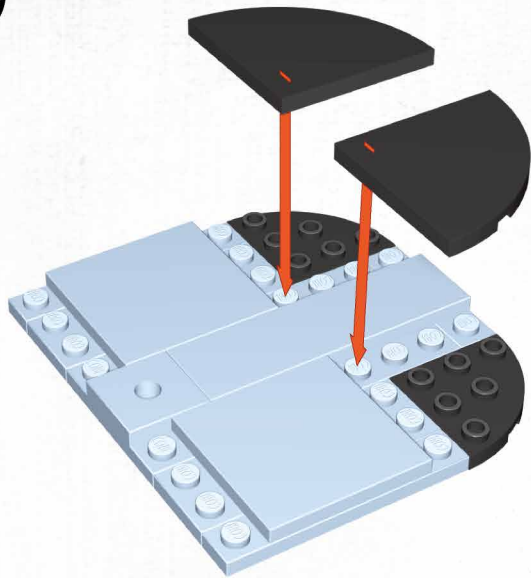

x2



x2

106

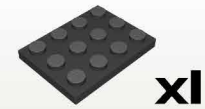
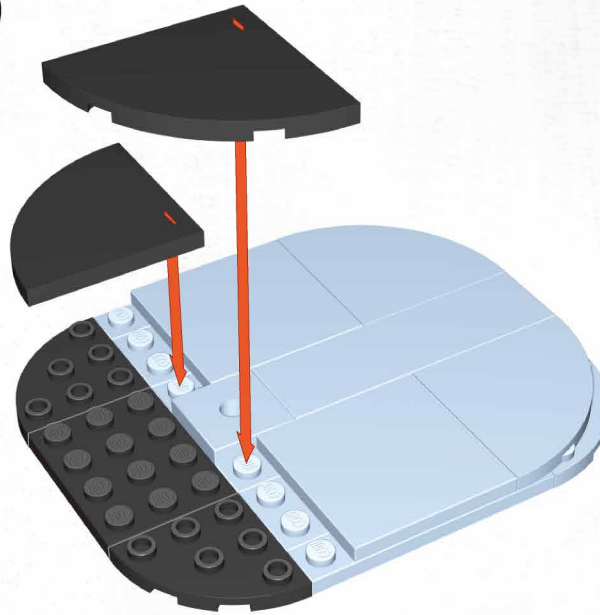

x1



x2



x2

107

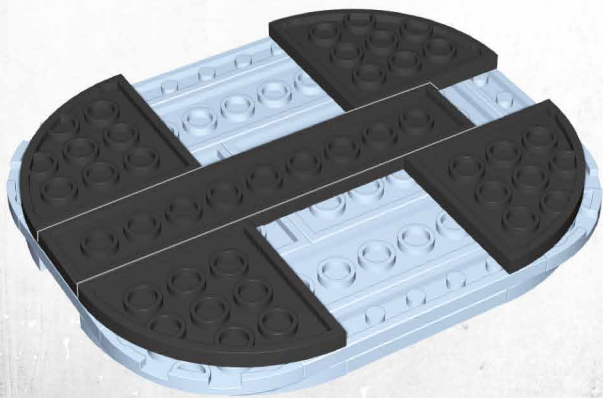

x1

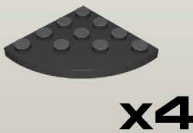

x4

108

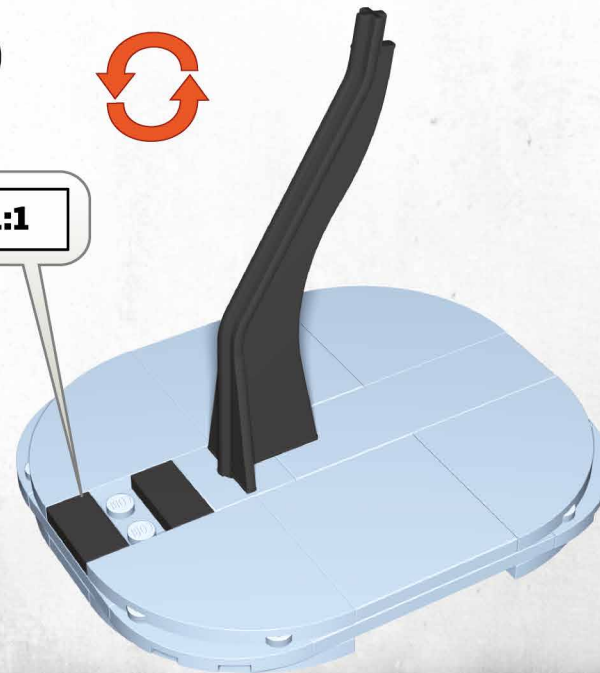
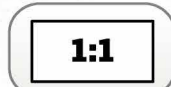

x2

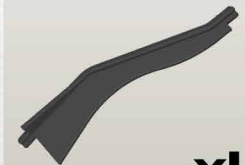

x1

x2



x1



x1

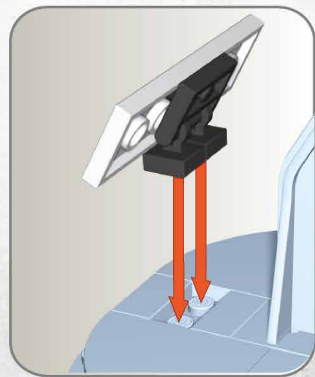
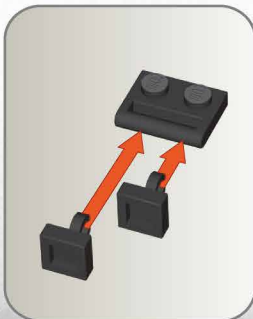
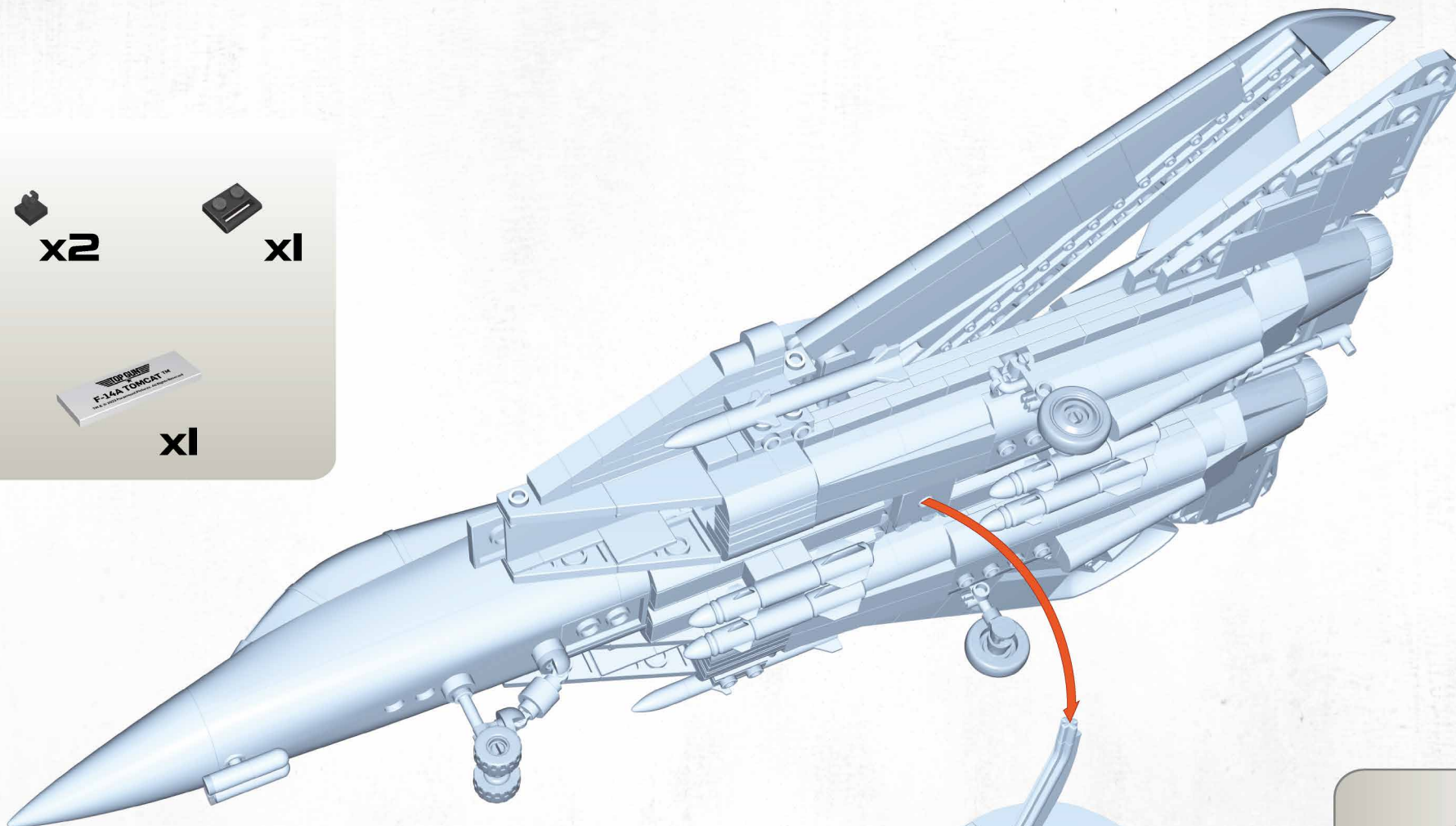



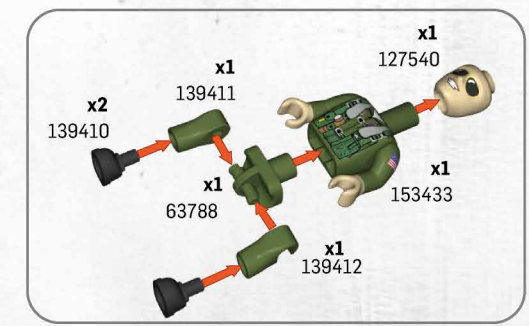
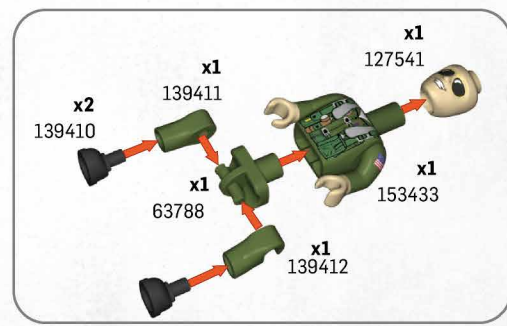



COMPANY OF HEROES
🇮🇹 🇺🇸 🇫🇷 🇬🇧 3041



CHURCHILL MK. III
🇬🇧 3046

COMPANY OF HEROES 3



8,8cm FLAK
🇫🇷 3047



PANZER IV Ausf. G
🇫🇷 3045

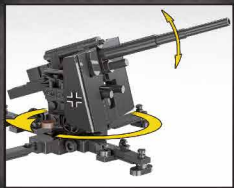



COMPANY OF HEROES 3



US AIR SUPPORT CENTER

★ 3042



GERMAN FIGHTING POSITION

⚔ 3043



Produced under license from Boeing. Boeing and F/A-18 Hornet are trademarks of The Boeing Company.



F/A-18C HORNET™
5810



F-35®B LIGHTNING II®
5829



F-35®A LIGHTNING II®
5832



LOCKHEED MARTIN®, F-35®B Lightning II®, associated emblems and logos, and body designs of vehicles are either registered trademarks or trademarks of Lockheed Martin Corporation in the USA and/or other jurisdictions, used under license by COBI.

LOCKHEED MARTIN®, F-35®A Lightning II®, associated emblems and logos, and body designs of vehicles are either registered trademarks or trademarks of Lockheed Martin Corporation in the USA and/or other jurisdictions, used under license by COBI.



F-35®B LIGHTNING II®
5830

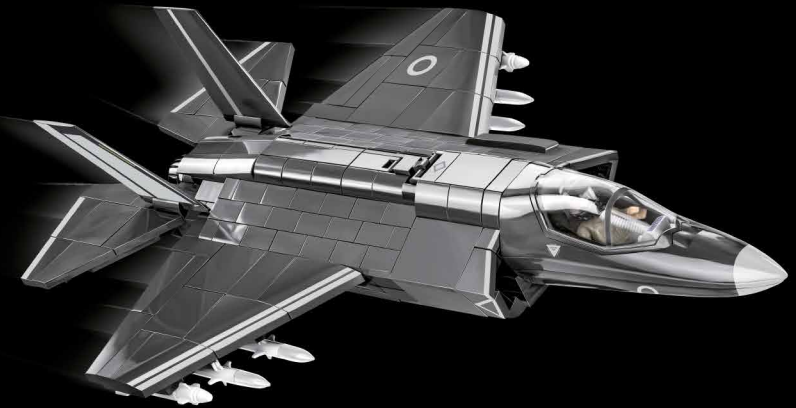



TOP GUN MAVERICK

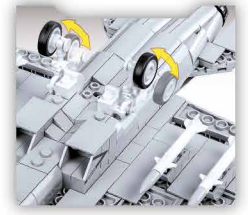
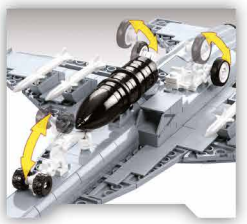

F/A-18E SUPER HORNET™
5805



TM & © 2023 Paramount Pictures. All Rights Reserved



F/A-18E SUPER HORNET™
5804



Produced under license from Boeing. Boeing, F/A-18E Super Hornet, the distinctive Boeing logos, product markings and trade dress are trademarks of The Boeing Company.

WWW.COBI.EU

03-05811A-752

For
news and
special deals

Find us on:

